

Practice Instant Challenges

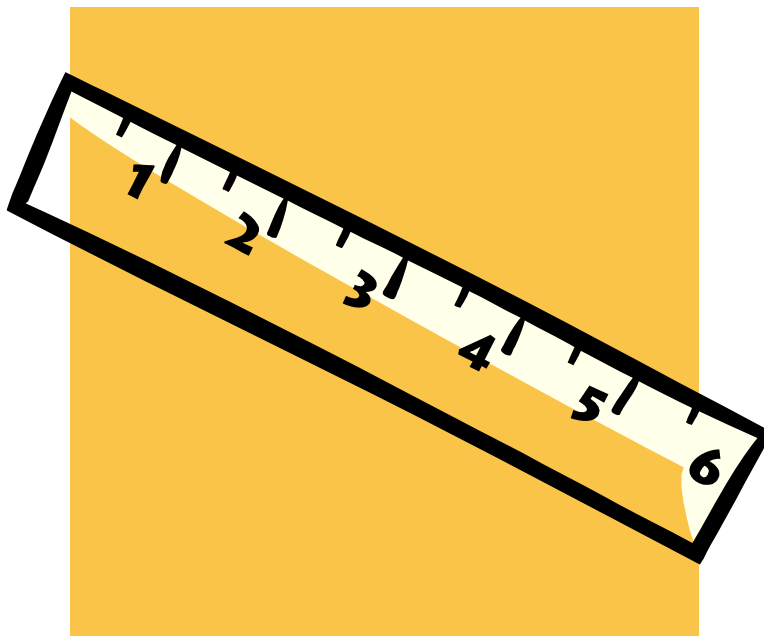

Set B

Find more free Instant Challenges online at:
<http://mysite.verizon.net/vze2z83j/ic/>

Introduction

Purpose

I wrote these Instant Challenges to help Elementary Team Managers, although most Team Managers will find them helpful. When training a Destination Imagination team, practicing Instant Challenges is absolutely necessary. Especially with Elementary Level teams, it is essential that they are familiar with what kinds of challenges they may be asked to solve. In my experience, Elementary Level teams require intense training to become proficient at the Instant Challenge. Thus, in many cases, proficiency is not attained because many Team Managers either underestimate the importance of the Instant Challenge, overestimate the abilities of their team, or simply don't understand how best to train them. For the purposes of this book, I will assume that my audience has a basic knowledge of the Instant Challenge and what Destination Imagination says about training a team for the Instant Challenge.

I created my Instant Challenges to look as much like real Instant Challenges from Destination Imagination as possible. When teams practice Instant Challenges, it is important that what they are experiencing is as close to what will happen at the tournament as possible. While it is essential that the team develop the skills necessary to solve Instant Challenges, it helps their scores (or at least their confidence) if they aren't surprised by the format of the challenge. This includes not only the types of materials they may have to work with or the kinds of things for which they will typically be awarded points, but also details such as the font, organization, and length of the challenge.

In the spirit of that concept, I have studied about 200 Instant Challenges released by Destination Imagination and I tried to make my challenges as much like those as possible. However, the challenges released by Destination Imagination have changed formats over time; even two challenges in the same book may be structured differently. As Instant Challenges continue to evolve, my practice versions may become slightly outdated as far as the format is concerned.

My intent is not to replace the need to use Instant Challenges released by Destination Imagination. Nor is it to eliminate skill-building exercises that are not in the format of Instant Challenges. It is to give the Team Manager a library of Instant Challenges from which to choose for practices. My challenges are designed for use as a team is developing skills and experimenting with techniques. Once the team has fine-tuned their abilities, they should practice with official Instant Challenges. As a minimum, the team should practice the ten or so challenges released with the Program Materials annually.

Insight into the Regional and Affiliate Challenges

The challenges released each year are all categorized as Entry and Advanced Levels, and as far as I can tell, these are the challenges that were used at the regional and affiliate tournaments the year before. This is valuable information because it lends insight as to what types of challenges will be given to teams. This means that (at the regional and affiliate tournaments) any team has the possibility of getting a task-based challenge, a performance-based challenge, or a hybrid challenge.

It also means Elementary teams may be getting a challenge slightly above their skill level and High School teams may be getting a challenge slightly below their skill level. Of course, it doesn't matter how hard a challenge is because all teams competing against each other are given the same challenge, but it does give the Team Manager a good idea of what will be expected of the team.

This is not to imply that only a High School team could successfully do an Advanced Level Challenge. In fact, I believe that an Elementary team could potentially be trained to do Advanced Level Instant Challenges, if they spent enough time practicing. However, this extra time is not often available to Elementary Level teams that meet once a week.

Practicing vs. Training

There is a big difference between practicing Instant Challenges and training for the Instant Challenge. The average Elementary Team should see the Instant Challenge as something they should prepare for and do their best on, but they should not spend large amounts of time training for it because they also have a 300 point Central Challenge for which to prepare. One Instant Challenge per meeting is ideal for the team that wants to be moderately competitive, but not obsessively prepared.

Competitive teams who want to maximize their instant Challenge scores should spend 1 hour a week practicing Instant Challenges. These teams should focus on training the types of instant challenges that on which they routinely perform most weakly. More often than not, this type of challenge will be Task-Based. Most challenges that are exclusively Entry Level are Performance-based and most challenges that are exclusively Advanced Level are Task-Based. Since most teams need to train for a Task-Based Instant Challenge, and most of the Task-Based Challenges released by Destination Imagination call for some elaborate apparatus that would only appear at the Global Finals Tournament, I wrote many of these Instant Challenges with such teams in mind. It is my hope that these challenges help those teams that need more task-based challenges such as those that might appear at a regional or affiliate level tournament.

Disclaimer

It is important that I note that these Instant Challenges are meant only to mimic those released by Destination Imagination. These are not official Destination Imagination Instant Challenges. Also, the inspiration for these challenges came from a variety of sources, including www.spiritofchicago.org, a web site with hundreds of exercises meant to build the skills necessary to solve Instant Challenges.

Preparing to Practice an Instant Challenge



After several years of bringing Instant Challenges to team meetings, I have developed a helpful system for preparing Instant Challenges for a team to practice. These are some things that I find helpful:

1. Keep each challenge in a gallon-sized plastic bag. The bag should include at least two copies of the challenge, any accompanying worksheets necessary, and the materials needed to work through the Instant Challenge. I reuse these plastic bags from week to week, and I find that they keep everything together and make for a quicker setup.
2. Select the Instant Challenge carefully. Make sure that it is at the team's level. Don't just go by the level stated at the top of the Appraiser's Copy—read it through and consider the team's actual abilities. You want something that will challenge the team so they can learn from it, but it is impossible to learn from a challenge that is too difficult.
3. It is essential that the team has experience with performance-based, task-based, and hybrid challenges, although it may not be necessary to practice the same amount of each type. If a team excels at performance-based challenges but needs work on task-based ones, you may need to give them more task-based ones to practice.
4. Read and re-read the challenge. Make sure you will be able to realistically practice the challenge. You may need more materials than the ones listed for the team to use. The challenge may call for an unrealistic apparatus or a tub of water you don't want to have to deal with.
5. Make challenge packing faster by having common Instant Challenge supplies gathered at a specific location. On the next page, there is a more detailed handout about the supplies you should have on hand.
6. Time permitting, pack more than one challenge at once. It will be one less thing to do before the next meeting.
7. If you will manage more teams in the future, it's good to develop a set of favorite Instant Challenges. Remember the challenges that teach teams the most or are easy to prepare for.

Instant Challenge Materials to Have on Hand

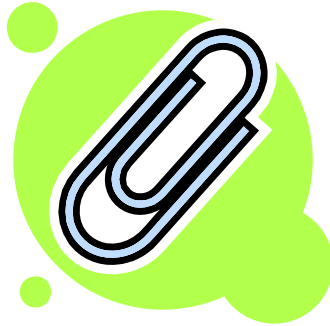

Whether this will be your last year as a Team Manager or you plan on managing many more teams, it is a good idea to have a bunch of the common Instant Challenge materials in one place. This will make it much faster and less frustrating when preparing for the next team meeting. The size and contents of your set of materials will vary depending on how many years you plan being a Team Manager and the amount of instant challenges you plan on practicing. Each year I buy everything necessary to do the challenges released in the Instant Challenge Practice Set. These challenges are the same ones from the regional and affiliate tournaments of the past year, so they are the best ones to use to gage your team's skill level.

The most basic materials are as follows:

Mailing Labels	Pencils
Chenille Sticks	Craft Sticks
Straws	Styrofoam Cups
Rubber Bands	Foil (Pre-cut sheets make it easy)
String	Index Cards
Paper Clips	Timer (for Appraiser)
Plain White Paper	Painter's Tape (for boundaries)

You may have these supplies already in your house, but having them in one place makes it much easier to prepare an individual challenge. As you do more Instant Challenges, you may find that other materials are common enough to be kept aside as well. I like to keep all of my Instant Challenge resources (released practice sets, books from Destination Imagination, printed program materials, challenges I've written, etc.) together with my materials. The containers for my materials are, themselves, materials as well. Whenever I do a water challenge, the tub comes in handy, and several older challenges list a trash can as a material. A growing collection of challenges and materials will help in future years to make preparation for practicing an Instant Challenge much easier.

Practicing an Instant Challenge with a Team



1. Set up the Instant Challenge(s) before the meeting begins. Tape any boundaries, lay out and sort the materials neatly, set the timer, and place copies of the challenge out for the team. This will allow for a quick transition when you're ready.
2. Read the entire Instant Challenge from the Appraiser's Copy to the team as they read along with the Team Copy. When finished with the Scoring section, reread the challenge section.
3. Begin time immediately. The team should be used to going headfirst into a Challenge because you never know how an appraiser may conduct the challenge at the tournament.
4. Do not share any information from the sheet marked "For Appraiser's Only" unless the team asks a specific question that is answered on the sheet.
5. Unless you are directed by the "For Appraisers Only" sheet, do not remind the team of any rules unless they specifically ask. If they ask, read straight from the challenge if at all possible.
6. Do not allow the team any leeway. If the challenge says that they must have something done in order to proceed, and the team does not have it done, do not allow them to proceed. If the team fails, let them do so. If they do not solve the challenge, end the challenge without trying to coax a solution out of them by giving them more time. Some of the best education is gained through failure.
7. Discuss the team's performance. DI has a list of ten things to discuss during this debriefing session. I simplify this into one major thing. Go through the scoring section and have the team (not you) score themselves on each of the things listed. Ask why they would give themselves that score. Ask if they can think of anything that would improve their score.
8. You may find it helpful to keep a running list of the things the team decides would improve their score. Review this list with the team before each Instant Challenge they do. If the team consistently forgets things on the list, assign specific team members to remember them for each challenge.
9. Now, if time allows and the team has discussed a better way of solving the challenge, give them more time to solve it. This ends the practice on a good note and it gives the team a great opportunity to develop skills.

Teamwork Exercise



I am forever coming up with new ways to teach teams how to succeed in the Instant Challenge. This activity takes some more extensive preparation and I haven't yet used it with a team, but I envision it being helpful to many Entry Level teams, especially those who have trouble on the Task-Based Challenges.

One very good way for the team to be prepared to solve a Task-Based Challenge efficiently is to practice as many different challenges as possible so they can apply the techniques they've learned were most effective in the past. But even this cannot be helpful in all situations because the Instant Challenge could very well involve materials the team has never worked with or require the team to use familiar materials in unfamiliar ways. In the vast majority of Task-Based Challenges, the team will be allowed to communicate while constructing their solution. I think that many teams could do much better at Task-Based Instant Challenges if they took part of the time to share ideas as a team. The trick to this is not to take too much time that they have no time left to use the materials, yet not to pick the first ideas that someone throws out.

Because is easier for an individual to have a clear idea of a solution than a group, begin the exercise by giving each team member an identical instant challenge and having them solve it alone. After each team member has presented his or her solution, make a list of the pros and cons about working alone. "Pros" should be defined as things that lead to a better solution, and "cons" should be defined as things that keep the solution from being spectacular. Keep this list written down on paper!

Next, put the team members into groups of two or three. When choosing the groups, do not try to put team members who you feel may work especially well together (or not well at all) together. Partner them so they're working with people they don't usually work with, but won't have a conflict with. Have each group solve an identical challenge as they did before. Create another list of pros and cons for working with a partner.

Repeat the above with groups of three and four. Be sure to make another list of pros and cons.

Now, do a challenge as a group. Make another list of pros and cons.

Have a team discussion. See if the team can come up with ways to apply the pros on each of the lists to challenges when working as a large group. Conversely, see if the team can come up with ways to avoid each of the cons on each of the lists. When conducting these discussions, accept all answers any team member puts forth (as long as they are being serious). It is the job of the rest of the team to decide if it is worth trying or not. Allow a constructive conversation. Under no circumstances should you ever tolerate shutdowns. No matter how seemingly dimwitted the idea is, if it was offered sincerely, allow it to be discussed. Never ask leading questions. Even if the team does not develop the "best" way to use teamwork to solve these challenges, any progress made will be theirs, allowing the learning process to fully take place. Allow the discussion to develop if it is still productive. You never know when the team may have a brilliant idea about how to work together. Make a list of every idea discussed. Have the team decide on the ones they feel are the best and denote them with a star.

Keep any lists of team ideas you make. If the team seems to need improvement during the season, have another discussion and use these lists as a starting point.

Instant Challenge Simulation Day

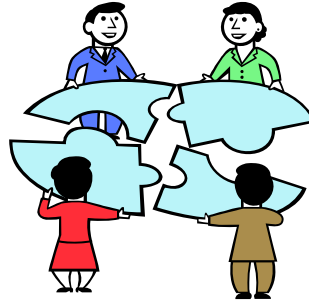

I have found that despite months of Instant Challenge Practice, the team can forget everything they learned just in time for the Tournament. To avoid this, try to simulate the challenge as exactly as possible.

1. Set up the Instant Challenge(s) just as you would do for a practice meeting. In my experience at tournaments, the team will be provided with two copies of the Team Copy, both in plastic sheet protectors. The materials list will be in a sheet protector taped to the table.
2. Have a set of "appraisers" with whom the team is not familiar. They should present the challenge just as you do when practicing with the team.
3. Hold the meeting in a new location, preferably a closed off room. This will hopefully provide new distractions and things to look at.
4. When the team enters the room, have the appraisers greet the team and introduce themselves.
5. Give each team member a slip of paper with the following typed on it:
"We promise not to talk about ANYTHING that we see, hear, do or say in this room UNTIL AFTER GLOBAL FINALS. If we are heard or are found to have shared this Challenge with anyone, we will be disqualified from the Tournament. However, we can talk about it privately among our team and Team Manager(s)!"
The team and Team Managers should read this out loud before proceeding with the challenge.
6. An appraiser should read the following:
WELCOME to the *Instant Challenge* portion of our Tournament! Anything is possible here, and you will have the opportunity to demonstrate your creative, "thinking on your feet" skills. For every team who is competing in your *Team Challenge* at your competition level, we will be presenting this *Instant Challenge* today.
7. Proceed to present the Instant Challenge the same way you do at practices.
8. When the challenge is over, the appraisers should thank the team, and the team should leave the room. You can debrief in a private area later, however you will not have a copy of the challenge to look at while debriefing on the tournament day.

Instant Challenge Promise Slips

"We promise not to talk about ANYTHING that we see, hear, do or say in this room UNTIL AFTER GLOBAL FINALS. If we are heard or are found to have shared this Challenge with anyone, we will be disqualified from the Tournament. However, we can talk about it privately among our team and Team Manager(s)!"

"We promise not to talk about ANYTHING that we see, hear, do or say in this room UNTIL AFTER GLOBAL FINALS. If we are heard or are found to have shared this Challenge with anyone, we will be disqualified from the Tournament. However, we can talk about it privately among our team and Team Manager(s)!"

"We promise not to talk about ANYTHING that we see, hear, do or say in this room UNTIL AFTER GLOBAL FINALS. If we are heard or are found to have shared this Challenge with anyone, we will be disqualified from the Tournament. However, we can talk about it privately among our team and Team Manager(s)!"

"We promise not to talk about ANYTHING that we see, hear, do or say in this room UNTIL AFTER GLOBAL FINALS. If we are heard or are found to have shared this Challenge with anyone, we will be disqualified from the Tournament. However, we can talk about it privately among our team and Team Manager(s)!"

Practice Instant Challenges

Set B

Table of Contents

CHALLENGE	TYPE	LEVEL	PAGE
A Lengthy Challenge	Task-Based	Entry	1
A Lengthy Challenge	Task-Based	Advanced	5
Animal Jamboree	Hybrid	Entry	9
Bowl-ing	Task-Based	Entry	13
Bowl-ing	Task-Based	Advanced	17
Bucket Ball	Task-Based	Advanced	21
Connection	Task-Based	Entry and Advanced	25
DI Mascot	Hybrid	Entry	29
Flip the Bridge	Task-Based	Entry and Advanced	33
Hold it!	Task-Based	Entry and Advanced	37
If Machines Could Talk...	Hybrid	Entry	41
Instrumental	Hybrid	Entry	45
It's in the Cards	Task-Based	Advanced	49
Line Drive	Task-Based	Entry and Advanced	53
Map Maker	Task-Based	Advanced	57
Marble Track	Task-Based	Entry and Advanced	65
No Hands	Task-Based	Entry and Advanced	69
Pick it Up!	Task-Based	Entry and Advanced	73
Postcard	Hybrid	Entry and Advanced	81
Rolling Along	Task-Based	Advanced	85
Round Trip	Task-Based	Entry and Advanced	89
Sculpture Story	Hybrid	Entry and Advanced	95
Shapes and Colors	Task-Based	Entry and Advanced	99
Show Some Restraint	Task-Based	Entry	105
Show Some Restraint	Task-Based	Advanced	109
Silent Movie	Performance-Based	Entry and Advanced	113
Sort it Out	Task-Based	Entry and Advanced	115
Splat!	Task-Based	Entry and advanced	119
Squared Away	Task-Based	Entry and Advanced	123
Still as a Statue	Performance-Based	Entry	127
Suspension Bridge	Task-Based	Entry and Advanced	129
Tall and Strong	Task-Based	Entry and Advanced	133
Underpass	Task-Based	Entry and Advanced	137

Instant Challenge
Entry Level
A Lengthy Challenge

Challenge: Your **TASK** is to sort colored craft sticks into containers.

Time: You will have up to 5 minutes to use your **IMAGINATION** to create one or more sorters and then up to 2 minutes to sort craft sticks for score.

Set-up: In the middle of the room is a taped line and three containers. In addition, there is a table with materials.

Procedure:

•**Part One** (5 minutes): Use the materials to build one or more sorters. You may practice sorting in Part One, however the sticks sorted will not receive score. You will be warned when you have one minute remaining and 30 seconds remaining in Part One.

•**Part Two** (2 minutes): Sort the sticks into the correct containers for score. **No team member may cross the taped line during Part Two.** The sticks may not be thrown.

Materials:

2 Straws 5 Rubber Bands 1 Piece of Poster Board 5 Mailing Labels
1 Dowel 2 Plastic Forks 3 Chenille Sticks 3 Paper Clips

The mailing labels may NOT be attached to the dowel. The dowel may not be damaged.

Scoring: You will receive

- A. Points for the craft sticks you sort into the correct container during Part Two:
 - 1 point for each red craft stick
 - 5 points for each green craft stick
 - 10 points for each purple craft stick
- B. Up to 30 points for how creatively you used the materials
- C. Up to 20 points for how well your team works together.

A Lengthy Challenge For Appraisers Only:

1. The set-up consists of a taped line and three containers. There is also a table with materials.

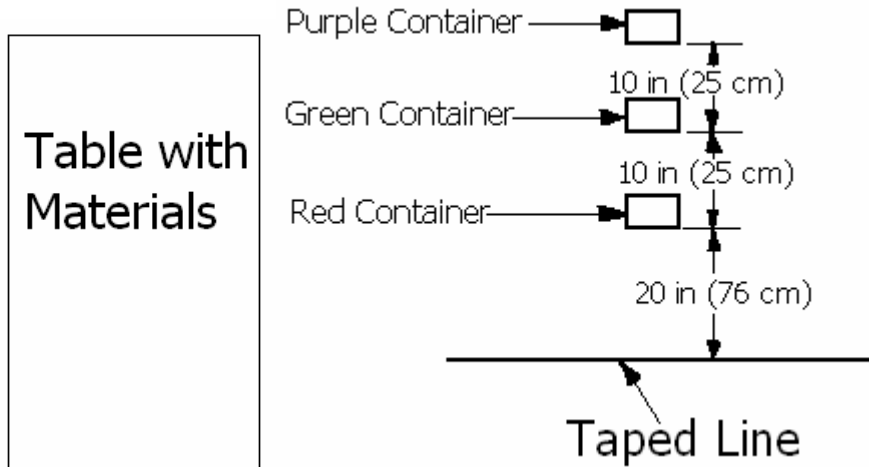

2. Be sure to warn the team when there is 1 minute remaining and 30 seconds remaining in Part One.
3. If a team member crosses the taped line during Part Two, they should be warned and any points the team may have gained as a result should not be awarded.
4. There should be 5 red craft sticks, 3 green craft sticks, and 3 purple craft sticks available to the team.

A Lengthy Challenge

Challenge: Your **TASK** is to sort colored craft sticks into containers.

Time: You will have up to 5 minutes to use your IMAGINATION to create one or more sorters and then up to 2 minutes to sort craft sticks for score.

Set-up: In the middle of the room is a taped line and three containers. In addition, there is a table with materials.

Procedure:

Part One (5 minutes):

- Use the materials to build one or more sorters.
- You may practice sorting in Part One, however the sticks sorted will not receive score.
- You will be warned when you have one minute remaining and 30 seconds remaining in Part One.

Part Two (2 minutes):

- Sort the sticks into the correct containers for score.
- **No team member may cross the taped line during Part Two.**
- The sticks may not be thrown.

Scoring: You will receive

- A. Points for the craft sticks you sort into the correct container during Part Two:
 - 1 point for each red craft stick
 - 5 points for each green craft stick
 - 10 points for each purple craft stick
- B. Up to 30 points for how creatively you used the materials
- C. Up to 20 points for how well your team works together.

A Lengthy Challenge

Materials:

(Tape to Table)

2 Straws

5 Rubber Bands

1 Piece of Poster Board

5 Mailing Labels

1 Dowel

2 Plastic Forks

3 Chenille Sticks

3 Paper Clips

The mailing labels may NOT be attached to the dowel. The dowel may not be damaged.

Instant Challenge
Advanced Level
A Lengthy Challenge

Challenge: Your **TASK** is to sort colored craft sticks into containers.

Time: You will have up to 5 minutes to use your **IMAGINATION** to create one or more sorters and then up to 2 minutes to sort craft sticks for score.

Set-up: In the middle of the room is a taped line and three containers. In addition, there is a table with materials.

Procedure:

•**Part One** (5 minutes): Use the materials to build one or more sorters. You may practice sorting in Part One, however the sticks sorted will not receive score. You will be warned when you have one minute remaining and 30 seconds remaining in Part One.

•**Part Two** (2 minutes): Sort the sticks into the correct containers for score. **No team member may cross the taped line during Part Two.** The sticks may not be thrown.

Materials:

1 Yardstick 5 Rubber Bands 1 Piece of Poster Board 5 Mailing Labels
1 Dowel 2 Plastic Forks 3 Chenille Sticks 3 Paper Clips

The mailing labels may NOT be attached to the yardstick or dowel. The yardstick and dowel may not be damaged.

Scoring: You will receive

- A. Points for the craft sticks you sort into the correct container during Part Two:
 - 1 point for each red craft stick
 - 5 points for each green craft stick
 - 10 points for each purple craft stick
- B. Up to 30 points for how creatively you used the materials
- C. Up to 20 points for how well your team works together.

A Lengthy Challenge For Appraisers Only:

1. The set-up consists of a taped line and three containers. There is also a table with materials.

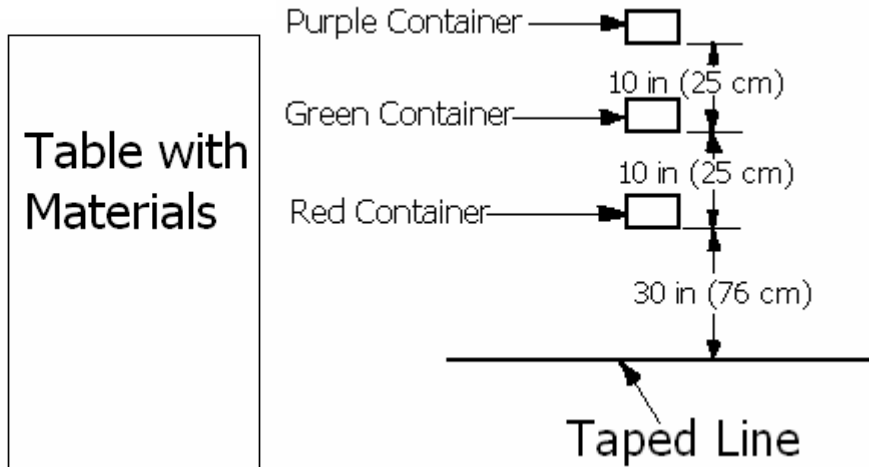

2. Be sure to warn the team when there is 1 minute remaining and 30 seconds remaining in Part One.
3. If a team member crosses the taped line during Part Two, they should be warned and any points the team may have gained as a result should not be awarded.
4. There should be 5 red craft sticks, 3 green craft sticks, and 3 purple craft sticks available to the team.

A Lengthy Challenge

Challenge: Your **TASK** is to sort colored craft sticks into containers.

Time: You will have up to 5 minutes to use your IMAGINATION to create one or more sorters and then up to 2 minutes to sort craft sticks for score.

Set-up: In the middle of the room is a taped line and three containers. In addition, there is a table with materials.

Procedure:

Part One (5 minutes):

- Use the materials to build one or more sorters.
- You may practice sorting in Part One, however the sticks sorted will not receive score.
- You will be warned when you have one minute remaining and 30 seconds remaining in Part One.

Part Two (2 minutes):

- Sort the sticks into the correct containers for score.
- **No team member may cross the taped line during Part Two.**
- The sticks may not be thrown.

Scoring: You will receive

- A. Points for the craft sticks you sort into the correct container during Part Two:
 - 1 point for each red craft stick
 - 5 points for each green craft stick
 - 10 points for each purple craft stick
- B. Up to 30 points for how creatively you used the materials
- C. Up to 20 points for how well your team works together.

A Lengthy Challenge

Materials:

(Tape to Table)

- 1 Yardstick
- 5 Rubber Bands
- 1 Piece of Poster Board
- 5 Mailing Labels
- 1 Dowel
- 2 Plastic Forks
- 3 Chenille Sticks
- 3 Paper Clips

The mailing labels may NOT be attached to the yardstick or dowel. The yardstick and dowel may not be damaged.

Instant Challenge
Entry Level
Animal Jamboree

Challenge: Your **TASK** is to create up to 5 animals. Your team should then present a **PERFORMANCE** in which you tell the names of these animals as well as what kind of animal they are.

Time: You will have up to 5 minutes to use your **IMAGINATION** to create your animals and to practice your **PERFORMANCE**. Your team will then have up to 2 minutes to present your **PERFORMANCE** to the Appraisers.

The Scene: Your team has found a bunch of animals. What kind of animals are they and what are their names?

•**Part One** (5 minutes): Use the materials to create up to 5 animals. Each animal should be made of more than one material. You should also use this time to plan your **PERFORMANCE**.

•**Part Two** (2 minutes): Present your **PERFORMANCE** to the Appraisers. During your **PERFORMANCE**, you should tell the names of the animals and what kind of animals they are.

Materials:

1 Glove 1 Pen 3 Paper Clips 5 Feathers 3 Cards
1 Piece of Paper 1 Piece of Foil 1 Golf Ball 4 Mailing Labels 4 Pennies

The mailing labels may not be attached to the golf ball, the pennies, or the pen. The golf ball, pennies, and pen may NOT be damaged. A piece of paper and a sharpened pencil also will be available for your team to use as you plan your **PERFORMANCE**.

Scoring: You will receive up to
A. 10 points (50 points maximum) for the creativity of the use of materials in each animal you create.
B. 3 points (15 points maximum) for the creativity of the name of each animal.
C. 3 points (15 points maximum) for the creativity of what kind of animal each one is.
D. 20 points for how well your team works together.

Animal Jamboree

For Appraisers Only:

1. The setup consists of a table with materials.

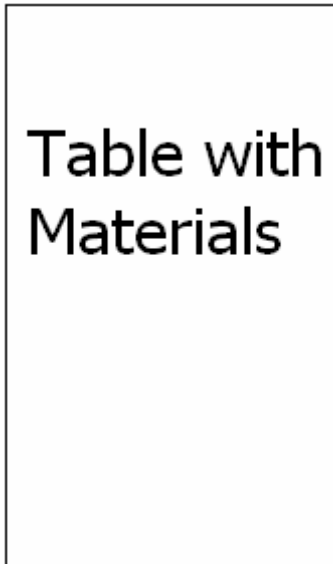

2. If more than one material is not used to create an animal, points should not be awarded for creativity of use of materials.

Animal Jamboree

Challenge: Your **TASK** is to create up to 5 animals. Your team should then present a **PERFORMANCE** in which you tell the names of these animals as well as what kind of animal they are.

Time: You will have up to 5 minutes to use your **IMAGINATION** to create your animals and to practice your **PERFORMANCE**. Your team will then have up to 2 minutes to present your **PERFORMANCE** to the Appraisers.

The Scene: Your team has found a bunch of animals. What kind of animals are they and what are their names?

Part One (5 minutes):

- Use the materials to create up to 5 animals.
- Each animal should be made of more than one material.
- You should also use this time to plan your **PERFORMANCE**.

Part Two (2 minutes):

- Present your **PERFORMANCE** to the Appraisers.
- During your **PERFORMANCE**, you should tell the names of the animals and what kind of animals they are.

Scoring: You will receive up to

- 10 points (50 points maximum) for the creativity of the use of materials in each animal you create.
- 3 points (15 points maximum) for the creativity of the name of each animal.
- 3 points (15 points maximum) for the creativity of what kind of animal each one is.
- 20 points for how well your team works together.

Animal Jamboree

Materials:

(Tape to Table)

1 Glove

1 Pen

3 Paper Clips

5 Feathers

3 Cards

1 Piece of Paper

1 Piece of Foil

1 Golf Ball

4 Mailing Labels

4 Pennies

The mailing labels may NOT be attached to the golf ball, the pennies, or the pen. The golf ball, pennies, and pen may NOT be damaged. A piece of paper and a sharpened pencil also will be available for your team to use as you plan your **PERFORMANCE**.

Instant Challenge
Entry Level
Bowl-ing

Challenge: Your **TASK** is to move a bowl filled with water down a lane as far as possible without spilling the water.

Time: You will have up to 5 minutes to use your IMAGINATION to develop a strategy and then up to 2 minutes to move the bowl for score.

Set-up: In the middle of the room is a taped lane with a bowl of water. In addition, there is a table with materials.

Procedure:

•**Part One** (5 minutes): Use the materials to create a method of moving the bowl. You may practice moving the bowl in Part One, however the distance moved will not receive score. You will be warned when you have one minute remaining and 30 seconds remaining in Part One.

•**Part Two** (2 minutes): At the beginning of Part Two, no materials may be inside the taped lane. Move the bowl for score. The bowl must stay within the taped lane in order to receive score. **No team member may cross the taped line during Part Two.** At the end of Part Two, the Appraisers will measure the distance from the starting point that the bowl traveled.

Materials:

2 Pieces of String	3 Rubber Bands	3 Mailing Labels	2 pieces of Paper
1 Piece of Foil	3 Straws	1 Envelope	1 Glove
1 Styrofoam Cup	1 Sponge	1 Piece of Cloth	

The mailing labels may NOT be attached to the bowl. The bowl may not be altered.

Scoring: You will receive

- A. 15 points for not spilling any water in Part Two.
- B. 10 points (50 points maximum) for each foot (30 cm) traveled by the bowl.
- C. Up to 15 points for how creatively you use the materials.
- D. Up to 20 points for how well your team works together.

Bowl-ing

For Appraisers Only:

1. The set-up consists of a taped lane and a bowl of water. There is also a table with materials.

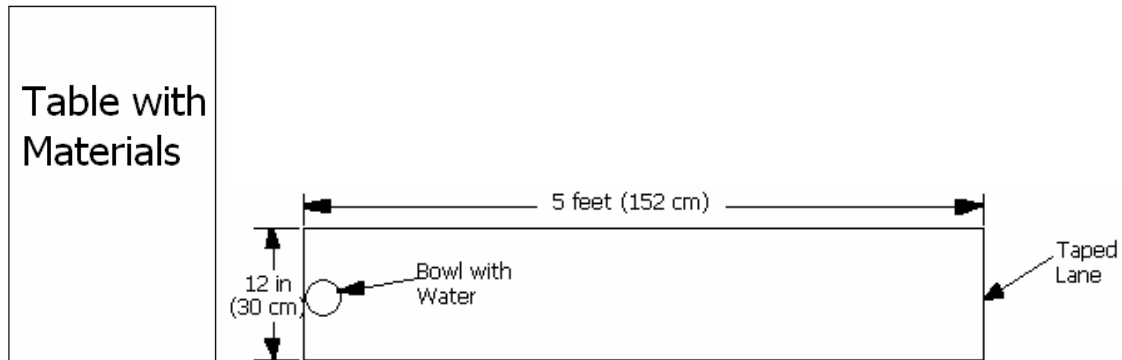

2. Be sure to warn the team when there is 1 minute remaining and 30 seconds remaining in Part One.
3. Be sure that the bowl is filled with the same amount of water before each team begins Part Two.
4. The bowl should be at one end of the taped lane sitting on the floor at the beginning of Part Two.
5. The team may lift the bowl with the materials if they want to.
6. If a team member crosses the taped line during Part Two, they should be warned and any points the team may have gained as a result should not be awarded.
7. Points should be awarded for the distance the bowl has moved only if the bowl got to where it is without touching any taped lines. If the bowl has touched any taped lines no points will be awarded. When the bowl touches a taped line, the team should be warned of this, and they may cross the taped line to move the bowl back to the starting position, and begin again.
8. You should have towels on hand in case any water spills.

Bowl-ing

Challenge: Your **TASK** is to move a bowl filled with water down a lane as far as possible without spilling the water.

Time: You will have up to 5 minutes to use your **IMAGINATION** to develop a strategy and then up to 2 minutes to move the bowl for score.

Set-up: In the middle of the room is a taped lane with a bowl of water. In addition, there is a table with materials.

Procedure:

Part One (5 minutes):

- Use the materials to create a method of moving the bowl.
- You may practice moving the bowl in Part One, however the distance moved will not receive score.
- You will be warned when you have one minute remaining and 30 seconds remaining in Part One.

Part Two (2 minutes):

- At the beginning of Part Two, no materials may be inside the taped lane.
- Move the bowl for score.
- The bowl must stay within the taped lane in order to receive score.
- **No team member may cross the taped line during Part Two.**
- At the end of Part Two, the Appraisers will measure the distance from the starting point that the bowl traveled.

Scoring: You will receive

- A. 15 points for not spilling any water in Part Two.
- B. 10 points (50 points maximum) for each foot (30 cm) traveled by the bowl.
- C. Up to 15 points for how creatively you use the materials.
- D. Up to 20 points for how well your team works together.

Bowl-ing

Materials:

(Tape to Table)

2 Pieces of String

3 Rubber Bands

3 Mailing Labels

2 Pieces of Paper

1 Piece of Foil

3 Straws

1 Envelope

1 Glove

1 Styrofoam Cup

1 Sponge

1 Piece of Cloth

The mailing labels may NOT be attached to the bowl.
The bowl may not be altered.

Instant Challenge

Advanced Level

Bowl-ing

Challenge: Your **TASK** is to move a bowl filled with water down a lane as far as possible without spilling the water.

Time: You will have up to 5 minutes to use your IMAGINATION to develop a strategy and then up to 2 minutes to move the bowl for score.

Set-up: In the middle of the room is a taped lane with a bowl of water. In addition, there is a table with materials.

Procedure:

•**Part One** (5 minutes): Use the materials to create a method of moving the bowl. You may practice moving the bowl in Part One, however the distance moved will not receive score. You will be warned when you have one minute remaining and 30 seconds remaining in Part One.

•**Part Two** (2 minutes): At the beginning of Part Two, no materials may be inside the taped lane. Move the bowl for score. The bowl must stay within the taped lane and not cross any taped lines in order to receive score. **No team member may cross the taped line during Part Two.** At the end of Part Two, the Appraisers will measure the distance from the starting point that the bowl traveled.

Materials:

2 Pieces of String	3 Rubber Bands	3 Mailing Labels	2 pieces of Paper
1 Piece of Foil	3 Straws	1 Envelope	1 Glove
1 Styrofoam Cup	1 Sponge	1 Piece of Cloth	

The mailing labels may NOT be attached to the bowl. The bowl may not be altered.

Scoring: You will receive

- A. 15 points for not spilling any water in Part Two.
- B. 10 points (50 points maximum) for each foot (30 cm) traveled by the bowl.
- C. Up to 15 points for how creatively you use the materials.
- D. Up to 20 points for how well your team works together.

Bowl-ing

For Appraisers Only:

1. The set-up consists of a taped lane and a bowl of water. There is also a table with materials.

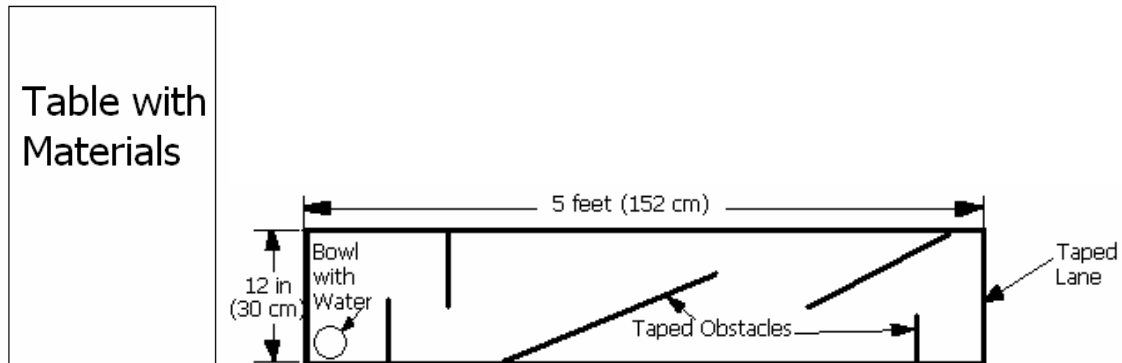

2. Be sure to warn the team when there is 1 minute remaining and 30 seconds remaining in Part One.
3. Be sure that the bowl is filled with the same amount of water before each team begins Part Two.
4. The bowl should be at one end of the taped lane sitting on the floor at the beginning of Part Two.
5. The team may lift the bowl with the materials if they want to.
6. If a team member crosses the taped line during Part Two, they should be warned and any points the team may have gained as a result should not be awarded.
7. Points should be awarded for the distance the bowl has moved only if the bowl got to where it is without touching any taped lines. If the bowl has touched any taped lines no points will be awarded. When the bowl touches a taped line, the team should be warned of this, and they may cross the taped line to move the bowl back to the starting position, and begin again.
8. The distance the bowl has traveled should be measured as a straight line from where the bowl started to where it ends.
7. You should have towels on hand in case any water spills.

Bowl-ing

Challenge: Your **TASK** is to move a bowl filled with water down a lane as far as possible without spilling the water.

Time: You will have up to 5 minutes to use your **IMAGINATION** to develop a strategy and then up to 2 minutes to move the bowl for score.

Set-up: In the middle of the room is a taped lane with a bowl of water. In addition, there is a table with materials.

Procedure:

Part One (5 minutes):

- Use the materials to create a method of moving the bowl.
- You may practice moving the bowl in Part One, however the distance moved will not receive score.
- You will be warned when you have one minute remaining and 30 seconds remaining in Part One.

Part Two (2 minutes):

- At the beginning of Part Two, no materials may be inside the taped lane.
- Move the bowl for score.
- The bowl must stay within the taped lane and not cross any taped lines in order to receive score.
- **No team member may cross the taped line during Part Two.**
- At the end of Part Two, the Appraisers will measure the distance from the starting point that the bowl traveled.

Scoring: You will receive

- A. 15 points for not spilling any water in Part Two.
- B. 10 points (50 points maximum) for each foot (30 cm) traveled by the bowl.
- C. Up to 15 points for how creatively you use the materials.
- D. Up to 20 points for how well your team works together.

Bowl-ing

Materials:

(Tape to Table)

2 Pieces of String

3 Rubber Bands

3 Mailing Labels

2 Pieces of Paper

1 Piece of Foil

3 Straws

1 Envelope

1 Glove

1 Styrofoam Cup

1 Sponge

1 Piece of Cloth

The mailing labels may NOT be attached to the bowl.
The bowl may not be altered.

Instant Challenge
Advanced Level
Bucket Ball

Challenge: Your **TASK** is to transport ping pong balls into a bucket.

Time: You will have up to 5 minutes to use your **IMAGINATION** to build a ball mover and then up to 1 minute to transport balls for score.

Set-up: In the middle of the room is a taped line and a bucket. In addition, there is a table with materials.

Procedure:

•**Part One** (5 minutes): Use the materials to create a ball mover. You may practice moving balls in Part One, however the balls moved will not receive score. In order to proceed to Part Two, you must have a ball mover by the end of Part One. You will be warned when you have one minute remaining and 30 seconds remaining in Part One.

•**Part Two** (1 minute): Move balls for score. The balls must cross from behind the taped line into the bucket. The empty bucket may not be moved. The balls may **NOT** be thrown (either by a ball mover or a team member). **No team member may cross over the taped line during Part Two.**

Materials:

1 Dowel 4 Cards 2 Pieces of String 1 Paper Cup 3 Mailing Labels
5 Straws 1 Stool 1 Piece of Foil 4 Rubber Bands 1 Piece of PVC Pipe
The mailing labels may **NOT** be attached to the dowel, the stool, or the PVC pipe. The dowel, stool, and PVC pipe may not be damaged.

Scoring: You will receive

- A. 2 Points (50 points maximum) for each ball that is in the bucket at the end of Part Two.
- B. Up to 15 points for how creatively you use the materials.
- C. Up to 15 points for the creativity of how you move the balls.
- D. Up to 20 points for how well your team works together.

Bucket Ball

For Appraisers Only:

1. The set-up consists of a bucket and a taped line. There is also a table with materials and balls. There should be 25 balls available.

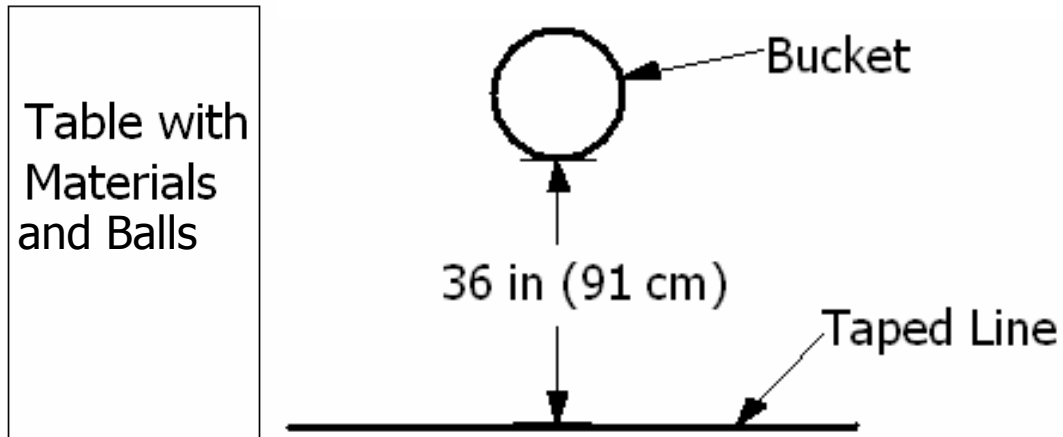

2. Be sure to warn the team when there is 1 minute remaining and 30 seconds remaining in Part One.
3. If a team member crosses over the taped line (even if they are trying to retrieve a ball) during Part Two, they should be warned and any points the team may have gained as a result should not be awarded.

Bucket Ball

Challenge: Your **TASK** is to transport ping pong balls into a bucket.

Time: You will have up to 5 minutes to use your **IMAGINATION** to build a ball mover and then up to 1 minute to transport balls for score.

Set-up: In the middle of the room is a taped line and a bucket. In addition, there is a table with materials.

Procedure:

Part One (5 minutes):

- Use the materials to create a ball mover.
- You may practice moving balls in Part One, however the balls moved will not receive score.
- In order to proceed to Part Two, you must have a ball mover by the end of Part One.
- You will be warned when you have one minute remaining and 30 seconds remaining in Part One.

Part Two (1 minute):

- Move balls for score.
- The balls must cross from behind the taped line into the bucket.
- The bucket may not be moved.
- The balls may NOT be thrown (either by a ball mover or a team member).
- **No team member may cross over the taped line during Part Two.**

Scoring: You will receive

- A. 2 Points (50 points maximum) for each ball that is in the bucket at the end of Part Two.
- B. Up to 15 points for how creatively you use the materials.
- C. Up to 15 points for the creativity of how you move the balls.
- D. Up to 20 points for how well your team works together.

Bucket Ball

Materials:

(Tape to Table)

1 Dowel

4 Cards

2 Pieces of String

1 Paper Cup

3 Mailing Labels

5 Straws

1 Stool

1 Piece of Foil

4 Rubber Bands

1 Piece of PVC Pipe

The mailing labels may NOT be attached to the dowel, the stool, or the PVC pipe. The dowel, stool, and PVC pipe may not be damaged.

Instant Challenge
Entry and Advanced Levels
Connection

Challenge: Your **TASK** is to connect two bricks in as many different ways as possible.

Time: You will have up to 6 minutes to use your **IMAGINATION** to connect the bricks for score.

Set-up: In the middle of the room are two bricks. In addition, there is a table with materials.

Procedure:

Use the materials to connect the two bricks. The bricks may not be moved. You will be warned when you have one minute remaining and 30 seconds remaining. When time ends, any connections that exist after ten seconds, are made of more than one material, do not touch any other connections, and do not touch the floor will be score.

Materials:

2 Spoons 1 Pencil 1 Piece of String 1 Piece of Paper 3 Rubber Bands
3 Straws 5 Paper Clips 3 Mailing Labels 1 Envelope 1 Plastic Bag

The mailing labels may NOT be attached to the bricks. The bricks may not be altered.

Scoring: You will receive

- A. 10 points (50 points maximum) for each connection after time ends.
- B. Up to 30 points for how creatively you use the materials.
- C. Up to 20 points for how well your team works together.

Connection

For Appraisers Only:

1. The set-up consists of two bricks. There is also a table with materials.

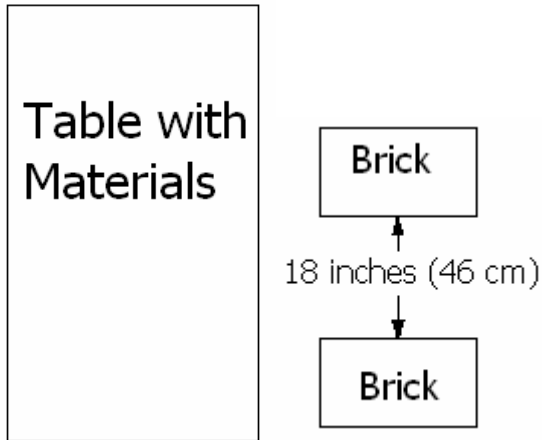

2. Be sure to warn the team when there is 1 minute remaining and 30 seconds remaining.
3. If two connections touch, they may be scored as one, as long as they are made of more than one material, exist ten seconds after time ends, and do not touch the floor.

Connection

Challenge: Your **TASK** is to connect two bricks in as many different ways as possible.

Time: You will have up to 6 minutes to use your **IMAGINATION** to connect the bricks for score.

Set-up: In the middle of the room are two bricks. In addition, there is a table with materials.

Procedure:

- Use the materials to connect the two bricks.
- The bricks may not be moved.
- You will be warned when you have one minute remaining and 30 seconds remaining.
- When time ends, any connections that exist after ten seconds, are made of more than one material, do not touch any other connections, and do not touch the floor will be score.

Scoring: You will receive

- A. 10 points (50 points maximum) for each connection after time ends.
- B. Up to 30 points for how creatively you use the materials.
- C. Up to 20 points for how well your team works together.

Connection

Materials:

(Tape to Table)

2 Spoons

1 Pencil

1 Piece of String

1 Piece of Paper

3 Rubber Bands

3 Straws

5 Paper Clips

3 Mailing Labels

1 Envelope

1 Plastic Bag

The mailing labels may NOT be attached to the bricks. The bricks may not be altered.

Instant Challenge
Entry Level
DI Mascot

Challenge: Your **TASK** is to create a Mascot for Destination Imagination. Your team should then present a **PERFORMANCE** in which you explain why your creation should be DI's mascot.

Time: You will have up to 5 minutes to use your IMAGINATION to create your mascot and to practice your **PERFORMANCE**. Your team will then have up to 2 minutes to present your **PERFORMANCE** to the Appraisers.

The Scene: Destination Imagination has asked your team to create a mascot for the program. Be sure to back up your nomination.

•**Part One** (5 minutes): Use the materials to create a mascot for DI. You should also use this time to plan your **PERFORMANCE**.

•**Part Two** (2 minutes): Present your **PERFORMANCE** to the Appraisers. During your **PERFORMANCE**, explain why your creation should be DI's mascot.

Materials:

5 Sheets of Paper 4 Cards 3 Mailing Labels Colored Markers Scissors
The markers and scissors may NOT be damaged and may not be part of your mascot. A piece of paper and a sharpened pencil also will be available for your team to use as you plan your **PERFORMANCE**.

Scoring: You will receive up to

- A. 25 points for how creatively you use the materials.
- B. 25 points for the creativity of your mascot.
- C. 30 points for how convincing your **PERFORMANCE** is.
- D. 20 points for how well your team works together.

DI Mascot

For Appraisers Only:

1. The setup consists of a table with materials.

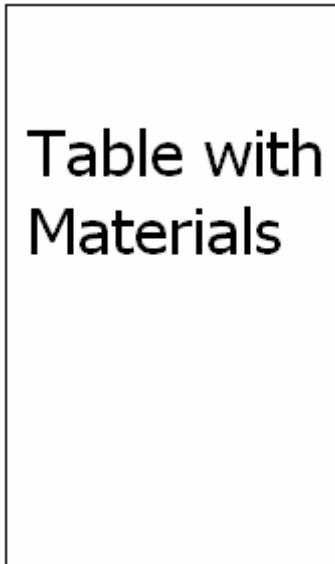

2. The appraisers should allow for a wide definition of the word "mascot".

DI Mascot

Challenge: Your **TASK** is to create a Mascot for Destination Imagination. Your team should then present a **PERFORMANCE** in which you explain why your creation should be DI's mascot.

Time: You will have up to 5 minutes to use your **IMAGINATION** to create your mascot and to practice your **PERFORMANCE**. Your team will then have up to 2 minutes to present your **PERFORMANCE** to the Appraisers.

The Scene: Destination Imagination has asked your team to create a mascot for the program. Be sure to back up your nomination.

Part One (5 minutes):

- Use the materials to create a mascot for DI.
- You should also use this time to plan your **PERFORMANCE**.

Part Two (2 minutes):

- Present your **PERFORMANCE** to the Appraisers.
- During your **PERFORMANCE**, explain why your creation should be DI's mascot.

Scoring: You will receive up to

- A. 25 points for how creatively you use the materials.
- B. 25 points for the creativity of your mascot.
- C. 30 points for how convincing your **PERFORMANCE** is.
- D. 20 points for how well your team works together..

DI Mascot

Materials:

(Tape to Table)

5 Sheets of Paper

4 Cards

3 Mailing Labels

Colored Markers

Scissors

The markers and scissors may NOT be damaged and may not be part of your mascot. A piece of paper and a sharpened pencil also will be available for your team to use as you plan your **PERFORMANCE**.

Instant Challenge
Entry and Advanced Levels
Flip the Bridge

Challenge: Your **TASK** is to create a bridge that can be flipped upside down and will hold weight.

Time: You will have up to 5 minutes to use your IMAGINATION to build your bridge, up to 2 minutes to add weight, and then up to 1 minute to flip it upside down for score.

Set-up: In the middle of the room are two tables. In addition, there is a table with materials.

Procedure:

•**Part One** (5 minutes): Use the materials to build a bridge between the two tables. You may practice flipping it or adding weights in Part One, however neither will receive score. In order to proceed to Part Two, you must have a bridge by the end of Part One. You will be warned when you have one minute remaining and 30 seconds remaining in Part One.

•**Part Two** (2 minutes): Add weights for score. A weight will receive score if it is held by the bridge for ten seconds. **No team member may touch the bridge during Part Two.** The bridge does not have to support all the weights in order to proceed to Part Three. You must have a standing bridge at the end of Part Two in order to proceed to Part Three.

•**Part Three** (1 minute): Remove the weights from the bridge and flip the bridge upside down for score. In order to receive score, it must span the gap between the tables without any team member touching it.

Materials:

5 Marshmallows 1 Envelope 10 Toothpicks 3 Mailing Labels 3 Straws
1 Piece of String 1 Piece of Foil 3 Cards

The mailing labels may NOT be attached to the tables.

Scoring: You will receive

- A. 3 points (30 Points maximum) for eight weight held by the bridge in Part Two.
- B. 20 points if you flip the bridge in Part Three successfully.
- C. Up to 30 points for how creatively you use the materials
- D. Up to 20 points for how well your team works together.

Flip the Bridge

For Appraisers Only:

1. The set-up consists of two tables. There is also a table with materials.

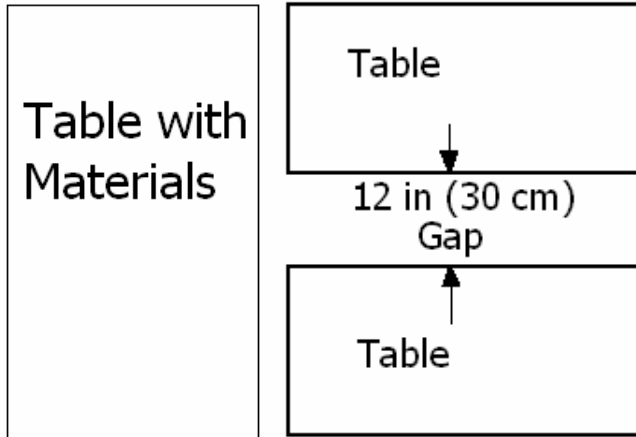

2. Be sure to warn the team when there is 1 minute remaining and 30 seconds remaining in Part One.
3. If a team member touches the bridge during Part Two, they should be warned and any points the team may have gained as a result should not be awarded.
4. The weights should each be two large nails tied together.

Flip the Bridge

Challenge: Your **TASK** is to create a bridge that can be flipped upside down and will hold weight.

Time: You will have up to 5 minutes to use your **IMAGINATION** to build your bridge, up to 2 minutes to add weight, and then up to 1 minute to flip it upside down for score.

Set-up: In the middle of the room are two tables. In addition, there is a table with materials.

Procedure:

Part One (5 minutes):

- Use the materials to build a bridge between the two tables.
- You may practice flipping it or adding weights in Part One, however neither will receive score.
- In order to proceed to Part Two, you must have a bridge by the end of Part One.
- You will be warned when you have one minute remaining and 30 seconds remaining in Part One.

Part Two (2 minutes):

- Add weights for score.
- A weight will receive score if it is held by the bridge for ten seconds.
- **No team member may touch the bridge during Part Two.**
- The bridge does not have to support all the weights in order to proceed to Part Three.
- You must have a standing bridge at the end of Part Two in order to proceed to Part Three.

Part Three (1 minute):

- Remove the weights from the bridge and flip the bridge upside down for score.
- In order to receive score, it must span the gap between the tables without any team member touching it.

Scoring: You will receive

- A. 3 points (30 Points maximum) for eight weight held by the bridge in Part Two.
- B. 20 points if you flip the bridge in Part Three successfully.
- C. Up to 30 points for how creatively you use the materials
- D. Up to 20 points for how well your team works together.

Flip the Bridge

Materials:

(Tape to Table)

5 Marshmallows

1 Envelope

10 Toothpicks

3 Mailing Labels

3 Straws

1 Piece of String

1 Piece of Foil

3 Cards

The mailing labels may NOT be attached to the tables.

Instant Challenge
Entry and Advanced Levels

Hold it!

Challenge: Your **TASK** is to build a bridge that will hold weight.

Time: You will have up to 5 minutes to use your **IMAGINATION** to build a bridge and then up to 2 minutes to add weight for score.

Set-up: In the middle of the room are two tables. In addition, there is a table with materials.

Procedure:

•**Part One** (5 minutes): Use the materials to build a bridge between the tables. You may practice adding weight in Part One, however the weight held will not receive score. Before Part Two begins, you must remove all weights on the bridge. In order to proceed to Part Two, you must have a bridge by the end of Part One. You will be warned when you have one minute remaining and 30 seconds remaining in Part One.

•**Part Two** (2 minutes): Add weights for score. A weight may only receive score if it is held for ten seconds without anything else touching the bridge.

Materials:

1 Piece of Paper 3 Cards 1 Piece of Cardstock

Scoring: You will receive

- A. 10 points if you have a bridge at the end of Part One.
- B. 10 points (50 points maximum) for each set of weights held.
- C. Up to 20 points for how creatively you use the materials
- D. Up to 20 points for how well your team works together.

Hold it!

For Appraisers Only:

1. The set-up consists of two tables. There is also a table with materials.

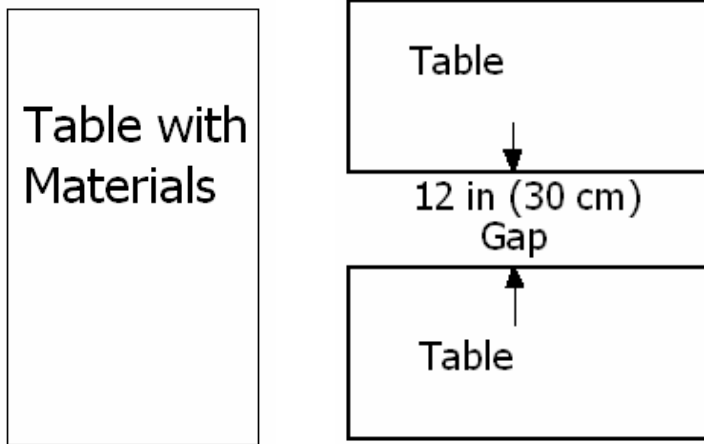

2. Be sure to warn the team when there is 1 minute remaining and 30 seconds remaining in Part One.
3. The weights should be sets of two large nails tied together.

Hold it!

Challenge: Your **TASK** is to build a bridge that will hold weight.

Time: You will have up to 5 minutes to use your IMAGINATION to build a bridge and then up to 2 minutes to add weight for score.

Set-up: In the middle of the room are two tables. In addition, there is a table with materials.

Procedure:

Part One (5 minutes):

- Use the materials to build a bridge between the tables.
- You may practice adding weight in Part One, however the weight held will not receive score.
- Before Part Two begins, you must remove all weights on the bridge.
- In order to proceed to Part Two, you must have a bridge by the end of Part One.
- You will be warned when you have one minute remaining and 30 seconds remaining in Part One.

Part Two (2 minutes):

- Add weights for score.
- A weight may only receive score if it is held for ten seconds without anything else touching the bridge.

Scoring: You will receive

- A. 10 points if you have a bridge at the end of Part One.
- B. 10 points (50 points maximum) for each set of weights held.
- C. Up to 20 points for how creatively you use the materials
- D. Up to 20 points for how well your team works together.

Hold it!

Materials:

(Tape to Table)

1 Piece of Paper

3 Cards

1 Piece of Cardstock

Instant Challenge
Entry Level

If Machines Could Talk...

Challenge: Your **TASK** is to create a machine costume. Your team should then present a **PERFORMANCE** in which a machine is able to talk.

Time: You will have up to 5 minutes to use your **IMAGINATION** to create your costume and to practice your **PERFORMANCE**. Your team will then have up to 2 minutes to present your **PERFORMANCE** to the Appraisers.

The Scene: Your team discovers a machine that can talk. What kind of machine is it and what does it say?

•**Part One** (5 minutes): Use the materials to create a machine costume. You should also use this time to plan your **PERFORMANCE**.

•**Part Two** (2 minutes): Present your **PERFORMANCE** to the Appraisers. During your **PERFORMANCE**, the machine should talk.

Materials:

2 Trash Bags	3 Pieces of Foil	1 Paper Plate	1 Paper Bag
3 Pieces of String	5 Paper Clips	3 Paper Cups	5 Mailing Labels
4 Chenille Sticks	4 Craft Sticks	5 Colored Markers	1 Pair of Scissors

The markers and scissors may NOT be damaged and may not be part of your costume. A piece of paper and a sharpened pencil also will be available for your team to use as you plan your **PERFORMANCE**.

Scoring: You will receive up to

- A. 20 points for the creativity of your costume.
- B. 20 points for the creativity of what the machine says.
- C. 20 points for the how clearly you tell a story.
- D. 20 points for the creativity of your **PERFORMANCE**.
- E. 20 points for how well your team works together.

If Machines Could Talk...

For Appraisers Only:

1. The setup consists of a table with materials.

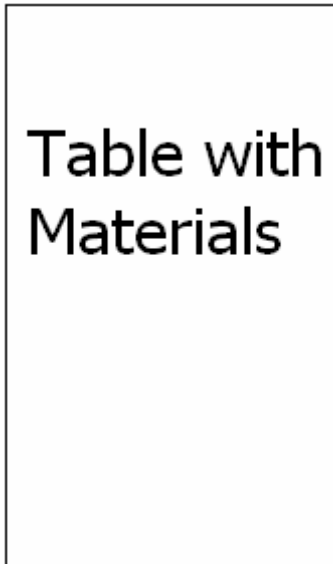

2. Remember to accept a wide definition of the word "costume".

TEAM COPY

If Machines Could Talk...

Challenge: Your **TASK** is to create a machine costume. Your team should then present a **PERFORMANCE** in which a machine is able to talk.

Time: You will have up to 5 minutes to use your **IMAGINATION** to create your costume and to practice your **PERFORMANCE**. Your team will then have up to 2 minutes to present your **PERFORMANCE** to the Appraisers.

The Scene: Your team discovers a machine that can talk. What kind of machine is it and what does it say?

Part One (5 minutes):

- Use the materials to create a machine costume.
- You should also use this time to plan your **PERFORMANCE**.

Part Two (2 minutes):

- Present your **PERFORMANCE** to the Appraisers.
- During your **PERFORMANCE**, the machine should talk.

Scoring: You will receive up to

- A. 20 points for the creativity of your costume.
- B. 20 points for the creativity of what the machine says.
- C. 20 points for the how clearly you tell a story.
- D. 20 points for the creativity of your **PERFORMANCE**.
- E. 20 points for how well your team works together.

If Machines Could Talk...

Materials:

(Tape to Table)

- 2 Trash Bags
- 3 Pieces of Foil
- 1 Paper Plate
- 1 Paper Bag
- 3 Pieces of String
- 5 Paper Clips
- 3 Paper Cups
- 5 Mailing Labels
- 4 Chenille Sticks
- 4 Craft Sticks
- 5 Colored Markers
- 1 Pair of Scissors

The markers and scissors may NOT be damaged and may not be part of your costume. A piece of paper and a sharpened pencil also will be available for your team to use as you plan your **PERFORMANCE**.

Instant Challenge
Entry Level
Instrumental

Challenge: Your **TASK** is to create two different musical instruments. Your team should then present a **PERFORMANCE** in which you show how to play the instruments.

Time: You will have up to 5 minutes to use your IMAGINATION to create your instruments and to practice your **PERFORMANCE**. Your team will then have up to 1 minute to present your **PERFORMANCE** to the Appraisers.

The Scene: Your team has just found two musical instruments. How do you play them?

•**Part One** (5 minutes): Use the materials to create two musical instruments. You should also use this time to plan your **PERFORMANCE**.

•**Part Two** (1 minute): Present your **PERFORMANCE** to the Appraisers. During your **PERFORMANCE**, you should show how to play each musical instrument.

Materials:

1 Plastic Container	3 Sheets of Colored Paper	5 Rubber Bands	2 Pencils	
2 Pieces of String	3 Straws	1 Piece of Foil	1 Glove	3 Cards
6 Mailing Labels	1 Piece of Cardboard	4 Dried Noodles	Scissors	

The scissors may NOT be damaged and may not be part of your musical instrument. A piece of paper and a sharpened pencil also will be available for your team to use as you plan your **PERFORMANCE**.

Scoring: You will receive up to

- A. 20 points (40 points maximum) for the creativity of each of your musical instruments.
- B. 10 points (20 points maximum) for how creatively you use the materials to create each instrument.
- C. 20 points for the creativity of your **PERFORMANCE**.
- D. 20 points for how well your team works together.

Instrumental

For Appraisers Only:

1. The setup consists of a table with materials.

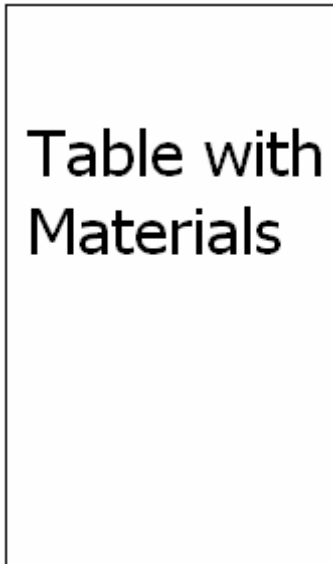

2. The team's musical ability is not scored anywhere.

Instrumental

Challenge: Your **TASK** is to create two different musical instruments. Your team should then present a **PERFORMANCE** in which you show how to play the instruments.

Time: You will have up to 5 minutes to use your **IMAGINATION** to create your instruments and to practice your **PERFORMANCE**. Your team will then have up to 1 minute to present your **PERFORMANCE** to the Appraisers.

The Scene: Your team has just found two musical instruments. How do you play them?

Part One (5 minutes):

- Use the materials to create two musical instruments.
- You should also use this time to plan your **PERFORMANCE**.

Part Two (1 minute):

- Present your **PERFORMANCE** to the Appraisers.
- During your **PERFORMANCE**, you should show how to play each musical instrument.

Scoring: You will receive up to

- A. 20 points (40 points maximum) for the creativity of each of your musical instruments.
- B. 10 points (20 points maximum) for how creatively you use the materials to create each instrument.
- C. 20 points for the creativity of your **PERFORMANCE**.
- D. 20 points for how well your team works together.

Instrumental

Materials:

(Tape to Table)

- 1 Plastic Container
- 3 Sheets of Colored Paper
- 5 Rubber Bands
- 2 Pencils
- 2 Pieces of String
- 3 Straws
- 1 Piece of Foil
- 1 Glove
- 3 Cards
- 6 Mailing Labels
- 1 Piece of Cardboard
- 4 Dried Noodles
- Scissors

The scissors may NOT be damaged and may not be part of your musical instruments. A piece of paper and a sharpened pencil also will be available for your team to use as you plan your **PERFORMANCE**.

Instant Challenge
Advanced Level
It's in the Cards

Challenge: Your **TASK** is to flip over as many cards as possible without crossing the taped lines.

Time: You will have up to 5 minutes to use your **IMAGINATION** to create one or more card flippers and then up to 2 minutes to flip cards for score.

Set-up: In the middle of the room is a taped square with cards inside. In addition, there is a table with materials.

Procedure:

•**Part One** (5 minutes): Use the materials to create one or more card flippers. You may practice flipping cards in Part One, however the cards flipped will not receive score. You will be warned when you have one minute remaining and 30 seconds remaining in Part One.

•**Part Two** (2 minutes): Flip cards for score. **No team member may cross the taped lines during Part Two.**

Materials:

1 Dowel 2 Pieces of Paper 1 Set of Chopsticks 3 Paper Clips 2 Feathers
1 Pencil 2 Chenille Sticks 3 Mailing Labels 1 Piece of Foil 1 Straw

The mailing labels may NOT be attached to the cards. The cards may not be altered.

Scoring: You will receive

- A. 5 points (50 points maximum) for each card flipped during Part Two.
- B. Up to 30 points for how creatively you use the materials.
- C. Up to 20 points for how well your team works together.

It's in the Cards

For Appraisers Only:

1. The set-up consists of a taped square with cards in the middle. The positions of the cards should be marked so they are in the same place for each team. There is also a table with materials.

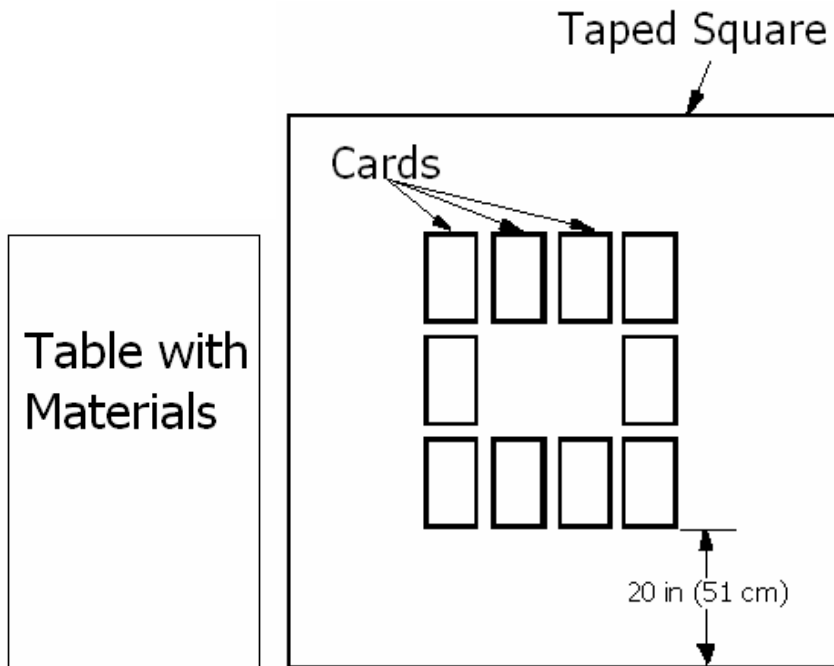

2. Be sure to warn the team when there is 1 minute remaining and 30 seconds remaining in Part One.
3. If a team member crosses the taped line during Part Two, they should be warned and any points the team may have gained as a result should not be awarded.
4. The cards do not have to be playing cards. They can be any type of card as long as one side is marked so it is clear when one is flipped.

It's in the Cards

Challenge: Your **TASK** is to flip over as many cards as possible without crossing the taped lines.

Time: You will have up to 5 minutes to use your **IMAGINATION** to create one or more card flippers and then up to 2 minutes to flip cards for score.

Set-up: In the middle of the room is a taped square with cards inside. In addition, there is a table with materials.

Procedure:

Part One (5 minutes):

- Use the materials to create one or more card flippers.
- You may practice flipping cards in Part One, however the cards flipped will not receive score.
- You will be warned when you have one minute remaining and 30 seconds remaining in Part One.

Part Two (2 minutes):

- Flip cards for score.
- No team member may cross the taped lines during Part Two.

Scoring: You will receive

- A. 5 points (50 points maximum) for each card flipped during Part Two.
- B. Up to 30 points for how creatively you use the materials.
- C. Up to 20 points for how well your team works together.

It's in the Cards

Materials:

(Tape to Table)

- 1 Dowel
- 2 Pieces of Paper
- 1 Set of Chopsticks
- 3 Paper Clips
- 2 Feathers
- 1 Pencil
- 2 Chenille Sticks
- 3 Mailing Labels
- 1 Piece of Foil
- 1 Straw

The mailing labels may NOT be attached to the cards.
The cards may not be altered.

Instant Challenge
Entry and Advanced Levels
Line Drive

Challenge: Your **TASK** is to create a device that will transport a rubber duck along a taped line.

Time: You will have up to 6 minutes to use your IMAGINATION to create your device and then up to 1 minute to travel along the line for score.

Set-up: In the middle of the room is a ramp and a taped line with pegs along each side. In addition, there is a table with materials.

Procedure:

•**Part One** (5 minutes): Use the materials to create a device to transport the duck along the taped line. You may practice transporting the duck in Part One, however the distance traveled will not receive score. In order to proceed to Part Two, you must have a transportation device by the end of Part One. You will be warned when you have one minute remaining and 30 seconds remaining in Part One.

•**Part Two** (1 minute): Move the rubber duck along the taped line for score. The transportation device should be placed on the ramp and let go. The device should not be pushed down the ramp. **No team member may touch the transportation device after it leaves the ramp during Part Two.** At the end of Part Two, the Appraisers will measure the distance traveled by the rubber duck.

Materials:

3 Straws **4 Mailing Labels** **1 Piece of Foil** **2 pieces of Paper**
8 Craft Sticks **3 Paper Clips** **4 Rubber Bands** **2 Pencils**

The mailing labels may NOT be attached to the rubber duck. The rubber duck may not be altered.

Scoring: You will receive

- A. 1 point for each peg left standing at the end of Part Two.
- B. 1 point (26 points maximum) for each inch (2.5 cm) traveled by the rubber duck.
- C. Up to 30 points for how creatively you use the materials.
- D. Up to 20 points for how well your team works together.

Line Drive

For Appraisers Only:

1. The set-up consists of a ramp and a taped line with pegs on either side. There should be 24 pegs. There is also a table with materials.

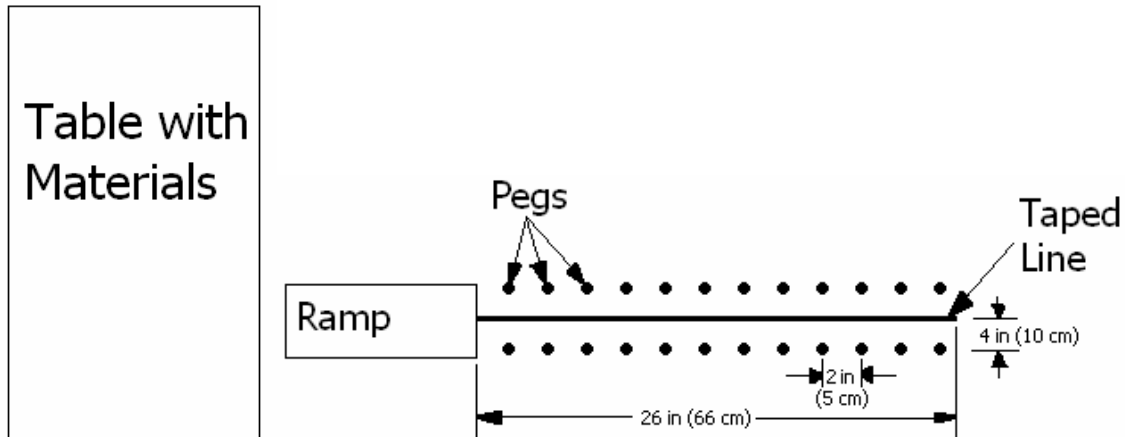

2. Be sure to warn the team when there is 1 minute remaining and 30 seconds remaining in Part One.
3. Be sure to set all the pegs up before Part Two starts.
4. If a team member touches the transportation device after it leaves the ramp during Part Two, they should be warned and any points the team may have gained as a result should not be awarded.
5. If a team member pushes the transportation device down the ramp, the team should not receive score for the distance traveled. An appraiser should be positioned to watch for this.
6. You should score the distance traveled by the rubber duck, not the transportation device. The distance traveled by the duck should be measured as a straight line from the beginning of the taped line to where the duck is.

Line Drive

Challenge: Your **TASK** is to create a device that will transport a rubber duck along a taped line.

Time: You will have up to 6 minutes to use your **IMAGINATION** to create your device and then up to 1 minute to travel along the line for score.

Set-up: In the middle of the room is a ramp and a taped line with pegs along each side. In addition, there is a table with materials.

Procedure:

Part One (5 minutes):

- Use the materials to create a device to transport the duck along the taped line.
- You may practice transporting the duck in Part One, however the distance traveled will not receive score.
- In order to proceed to Part Two, you must have a transportation device by the end of Part One.
- You will be warned when you have one minute remaining and 30 seconds remaining in Part One.

Part Two (1 minute):

- Move the rubber duck along the taped line for score.
- The transportation device should be placed on the ramp and let go.
- The device should not be pushed down the ramp.
- **No team member may touch the transportation device after it leaves the ramp during Part Two.**
- At the end of Part Two, the Appraisers will measure the distance traveled by the rubber duck.

Scoring: You will receive

- A. 1 point for each peg left standing at the end of Part Two.
- B. 1 point (26 points maximum) for each inch (2.5 cm) traveled by the rubber duck.
- C. Up to 30 points for how creatively you use the materials.
- D. Up to 20 points for how well your team works together.

Line Drive

Materials:

(Tape to Table)

3 Straws

4 Mailing Labels

1 Piece of Foil

2 Pieces of Paper

8 Craft Sticks

3 Paper Clips

4 Rubber Bands

2 Pencils

The mailing labels may NOT be attached to the rubber duck. The rubber duck may not be altered.

Instant Challenge

Advanced Level

Map Maker

Challenge: Your **TASK** is to communicate the directions on a map.

Time: You will have up to 5 minutes to use your **IMAGINATION** to create your communication system, up to 2 minutes to communicate the directions, and up to 1 minute to interpret the communication for score.

Set-up: In the middle of the room is a table and a screen. In addition, there is a table with materials.

Procedure:

•**Part One** (5 minutes): Use the materials to create a visual communication system. There is a practice map with directions and a practice blank map so you can practice communicating in Part One. You should also divide your team into communicators and interpreters. Each team member should be in a group and each group must have at least one team member. You will be warned when you have one minute remaining and 30 seconds remaining in Part One.

•**Part Two** (2 minutes): The interpreters should go behind the screen. The communicators will get a new map with directions. The communicators may place materials on the table. **No Team member may talk during Part Two.**

•**Part Three** (1 minute): The communicators should go behind the screen and the interpreters should come out. The interpreters will get a new blank map and a marker. The interpreters should look at the materials and draw the path from the map with directions onto the blank map. **No team member may talk during Part Three.**

Materials:

10 Craft Sticks 20 Toothpicks 16 Paper Clips 3 Pieces of Paper
5 Pieces of String 2 Styrofoam Cups 5 Pencils 1 Marker

The marker may NOT be altered and may NOT be part of your communication system.

Scoring: You will receive

- A. Up to 50 points for the accuracy of the map drawn by the interpreters.
- B. Up to 15 points for how creatively you use the materials.
- C. Up to 15 points for the complexity of the communication system.
- D. Up to 20 points for how well your team works together.

Map Maker

For Appraisers Only:

1. The set-up consists of a table and a screen. There is also a table with materials.

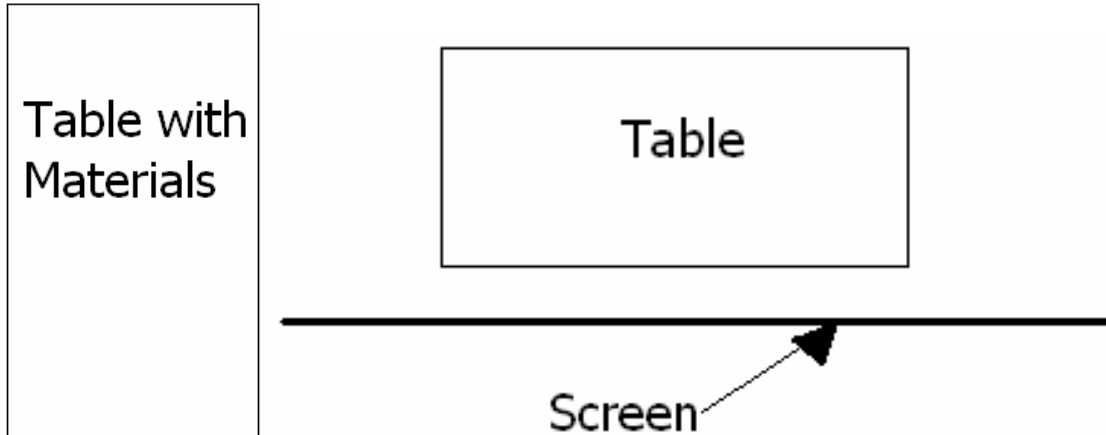

2. Be sure to warn the team when there is 1 minute remaining and 30 seconds remaining in Part One.
3. If a team member talks during Part Two or Part Three, they should be warned and any points the team may have gained as a result should not be awarded.

Map Maker

Challenge: Your **TASK** is to communicate the directions on a map.

Time: You will have up to 5 minutes to use your IMAGINATION to create your communication system, up to 2 minutes to communicate the directions, and up to 1 minute to interpret the communication for score.

Set-up: In the middle of the room is a table and a screen. In addition, there is a table with materials.

Procedure:

Part One (5 minutes):

- Use the materials to create a visual communication system.
- There is a practice map with directions and a practice blank map so you can practice communicating in Part One.
- You should also divide your team into communicators and interpreters.
- Each team member should be in a group and each group must have at least one team member.
- You will be warned when you have one minute remaining and 30 seconds remaining in Part One.

Part Two (2 minutes):

- The interpreters should go behind the screen.
- The communicators will get a new map with directions.
- The communicators may place materials on the table.
- **No Team member may talk during Part Two.**

Part Three (1 minute):

- The communicators should go behind the screen and the interpreters should come out.
- The interpreters will get a new blank map and a marker.
- The interpreters should look at the materials and draw the path from the map with directions onto the blank map.
- **No team member may talk during Part Three.**

Scoring: You will receive

- A. Up to 50 points for the accuracy of the map drawn by the interpreters.
- B. Up to 15 points for how creatively you use the materials.
- C. Up to 15 points for the complexity of the communication system.
- D. Up to 20 points for how well your team works together.

Map Maker

Materials:

(Tape to Table)

10 Craft Sticks

20 Toothpicks

16 Paper Clips

3 Pieces of Paper

5 Pieces of String

2 Styrofoam Cups

1 Marker

The marker may NOT be altered and may NOT be part of your communication system.

Blank Map:

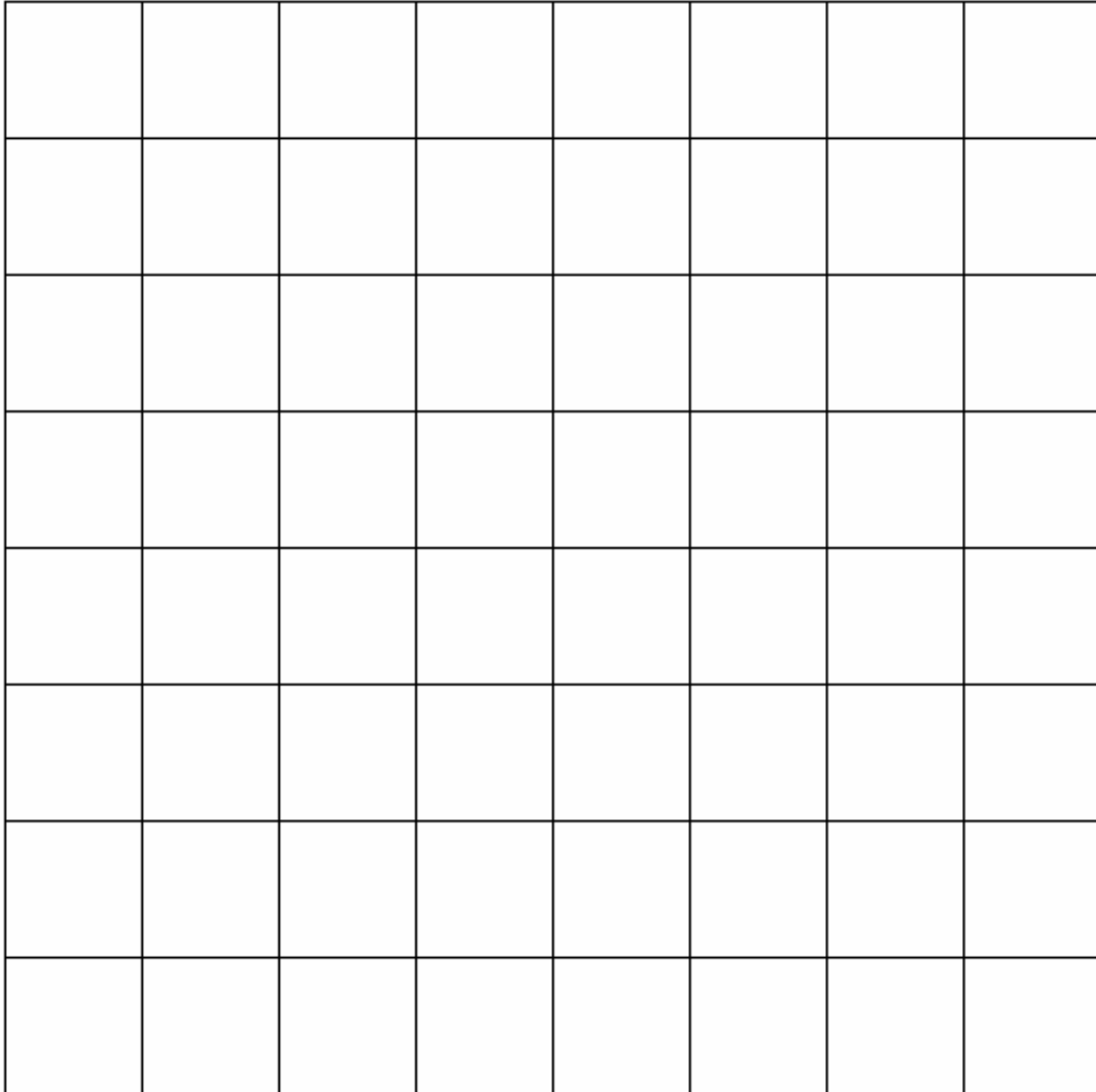

Practice Map:

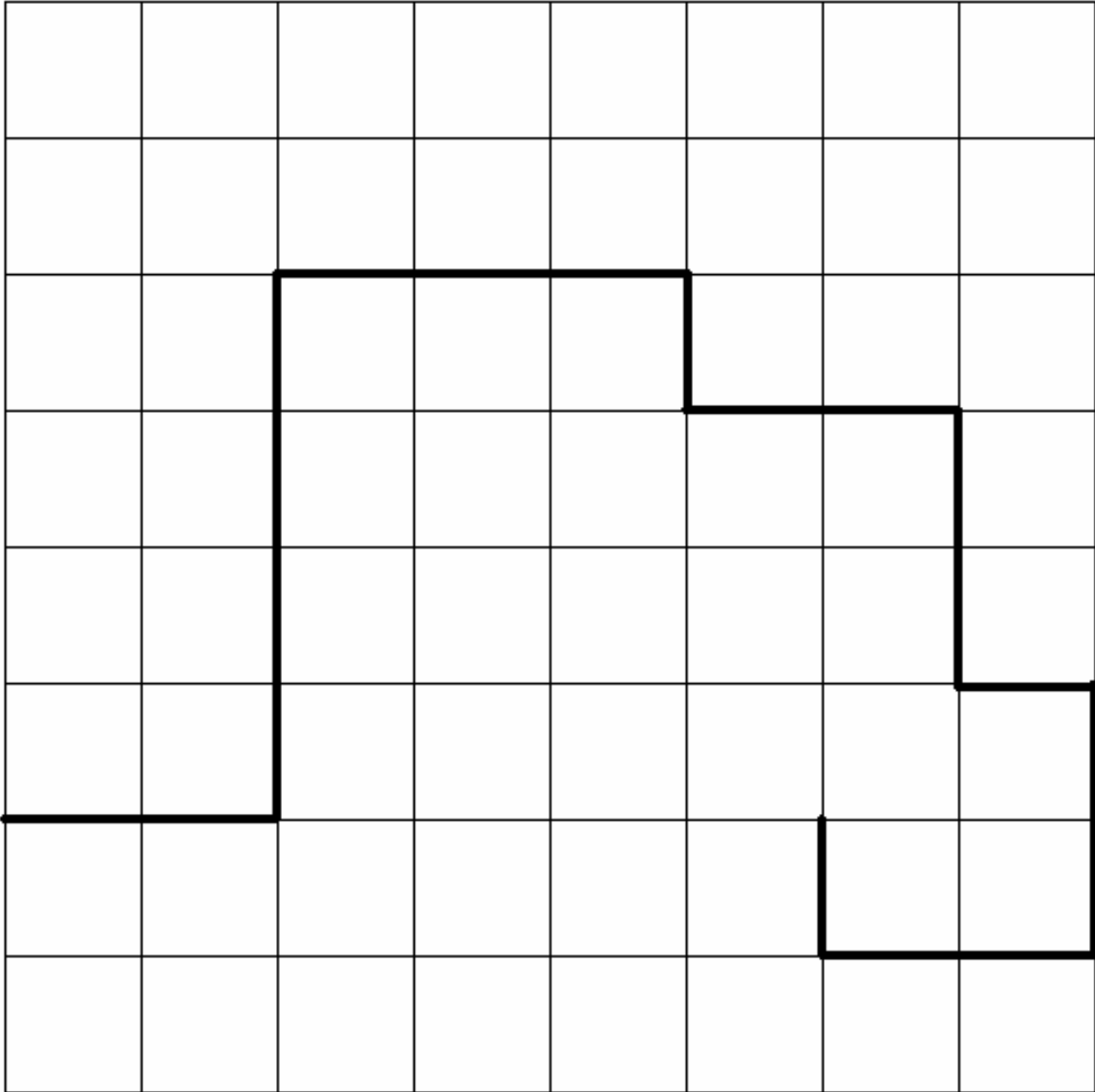

Map for Challenge:

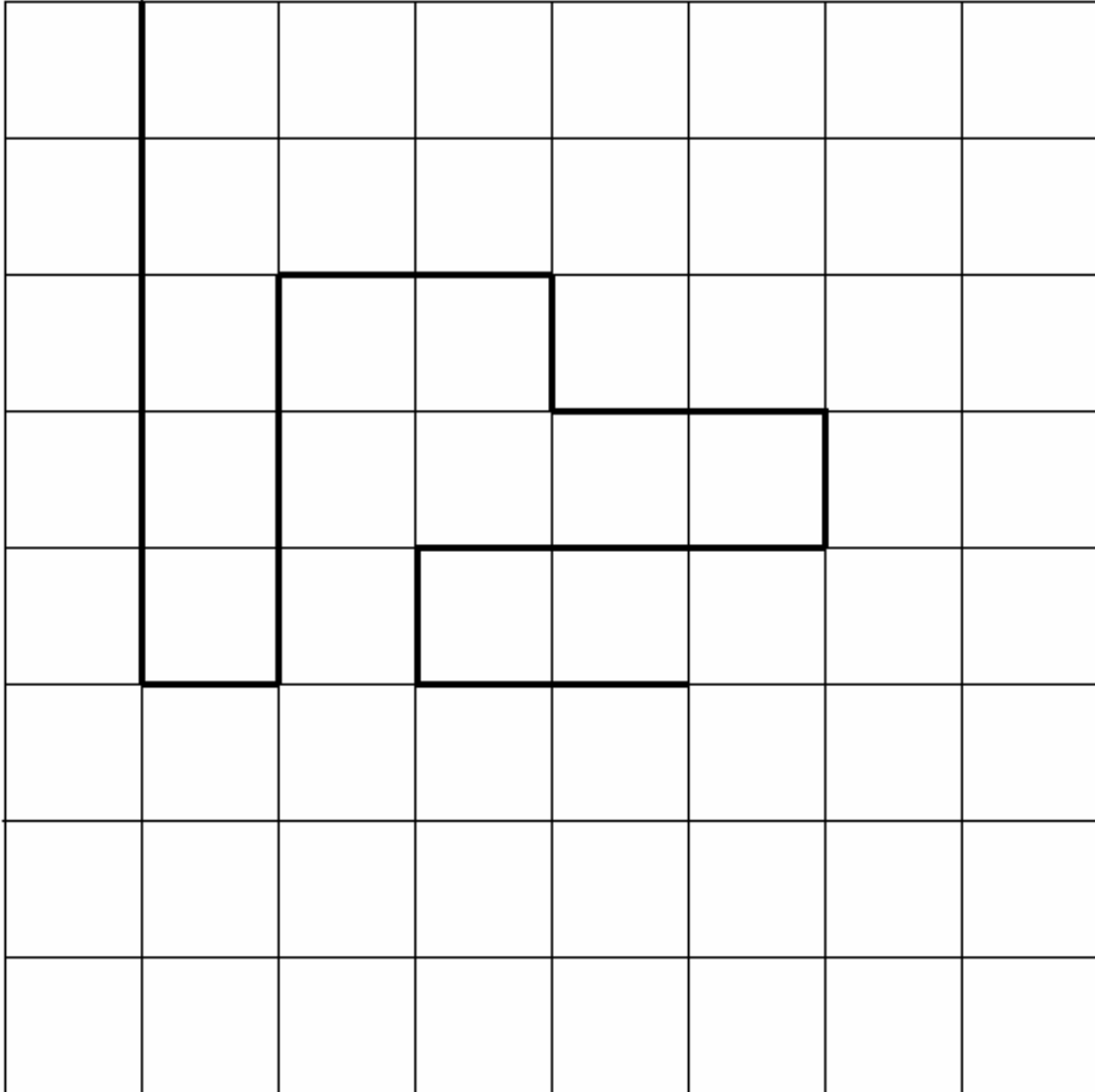

Instant Challenge
Entry and Advanced Levels
Marble Track

Challenge: Your **TASK** is to create a track that that will guide a marble into a taped square.

Time: You will have up to 5 minutes to use your **IMAGINATION** to build your track and then up to 1 minute to roll a marble for score.

Set-up: In the middle of the room is a taped square. In addition, there is a table with materials.

Procedure:

•**Part One** (5 minutes): Use the materials to create a track. You may practice rolling marbles in Part One, however the marbles rolled will not receive score. In order to proceed to Part Two, you must have a track by the end of Part One. You will be warned when you have one minute remaining and 30 seconds remaining in Part One.

•**Part Two** (1 minute): Roll a marble on the track for score. **The marble must be set on the track and propelled by gravity, rather than propelled down the track by a team member.** In order for a marble to receive score, it must stop within the taped square. More than one marble may be rolled, but only the highest-scoring marble will receive score. **No team member may touch the track or the marble as the marble is being rolled during Part Two.** At the end of Part Two, the Appraisers will measure the distance from the point on the track where the marble was dropped and the taped square.

Materials:

1 Piece of Cardstock 3 Straws 1 Piece of String 3 Sheets of Paper
5 Mailing Labels 4 Paper Clips 3 Rubber Bands 2 pencils

The mailing labels may NOT be attached to the floor.

Scoring: You will receive

- A. 25 points if a marble ends in the taped square in Part Two.
- B. 1 point for each inch (2.5 cm) between the point on the track where the marble was dropped and the taped square.
- C. Up to 30 points for how creatively you use the materials.
- D. Up to 20 points for how well your team works together.

Marble Track

For Appraisers Only:

1. The set-up consists of a taped square. There is also a table with materials.

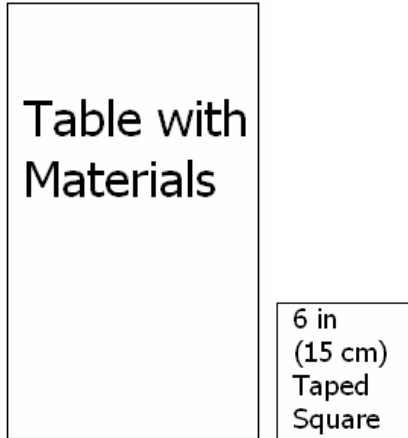

2. Be sure to warn the team when there is 1 minute remaining and 30 seconds remaining in Part One.
3. If a team member touches the track or the marble as the marble is being rolled during Part Two, they should be warned and any points the team may have gained as a result should not be awarded.
4. The track may go within the taped square. The track does not have to be all in one piece.
5. Appraisers should allow for a wide definition of the word "track".

Marble Track

Challenge: Your **TASK** is to create a track that that will guide a marble into a taped square.

Time: You will have up to 5 minutes to use your **IMAGINATION** to build your track and then up to 1 minute to roll a marble for score.

Set-up: In the middle of the room is a taped square. In addition, there is a table with materials.

Procedure:

Part One (5 minutes):

- Use the materials to create a track.
- You may practice rolling marbles in Part One, however the marbles rolled will not receive score.
- In order to proceed to Part Two, you must have a track by the end of Part One.
- You will be warned when you have one minute remaining and 30 seconds remaining in Part One.

Part Two (1 minute):

- Roll a marble on the track for score.
- **The marble must be set on the track and propelled by gravity, rather than propelled down the track by a team member.**
- In order for a marble to receive score, it must stop within the taped square.
- More than one marble may be rolled, but only the highest-scoring marble will receive score.
- **No team member may touch the track or the marble as the marble is being rolled during Part Two.**
- At the end of Part Two, the Appraisers will measure the distance from the point on the track where the marble was dropped and the taped square.

Scoring: You will receive

- A. 25 points if a marble ends in the taped square in Part Two.
- B. 1 point for each inch (2.5 cm) between the point on the track where the marble was dropped and the taped square.
- C. Up to 30 points for how creatively you use the materials.
- D. Up to 20 points for how well your team works together.

Marble Track

Materials:

(Tape to Table)

1 Piece of Cardstock

3 Straws

1 Piece of String

3 Sheets of Paper

5 Mailing Labels

4 Paper Clips

3 Rubber Bands

2 Pencils

The mailing labels may NOT be attached to the floor.

Instant Challenge
Entry and Advanced Levels
No Hands

Challenge: Your **TASK** is to create a structure that is as tall as possible without touching it with your hands.

Time: You will have up to 6 minutes to use your IMAGINATION to build your tower.

Set-up: In the middle of the room is a taped square. In addition, there is a table with materials.

Procedure:

Use the materials to build a structure within the taped square. **No team member's hands may enter the above the taped square.** You will be warned when you have one minute remaining and 30 seconds remaining. When time ends or when any team member wishes for time to end, an appraiser will measure the height of the structure.

Materials:

(May be damaged)

30 Cards 5 Mailing Labels

(May NOT be damaged and may NOT be part of the structure)

2 Pairs of Tongs 1 Set of Chopsticks 1 Yardstick 1 Piece of Rope 2 Dowels

The mailing labels may not be attached to the floor.

Scoring: You will receive

- A. 2 points for each inch (2.5 cm) tall your structure is.
- B. Up to 15 points for the creativity of the design of your structure.
- C. Up to 15 points for how creatively you used the materials
- D. Up to 20 points for how well your team works together.

No Hands

For Appraisers Only:

1. The set-up consists of a taped square. There is also a table with materials.

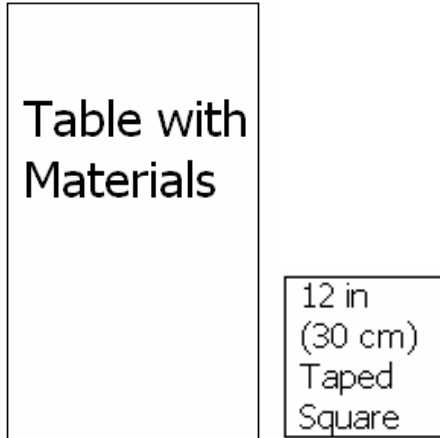

2. Be sure to warn the team when there is 1 minute remaining and 30 seconds remaining.
3. If a team member's hands enter into the taped area, they should be warned and any points the team may have gained as a result should not be awarded.

No Hands

Challenge: Your **TASK** is to create a structure that is as tall as possible without touching it with your hands.

Time: You will have up to 6 minutes to use your **IMAGINATION** to build your tower.

Set-up: In the middle of the room is a taped square. In addition, there is a table with materials.

Procedure:

- Use the materials to build a structure within the taped square.
- **No team member's hands may enter the above the taped square.**
- You will be warned when you have one minute remaining and 30 seconds remaining.
- When time ends or when any team member wishes for time to end, an appraiser will measure the height of the structure.

Scoring: You will receive

- A. 2 points for each inch (2.5 cm) tall your structure is.
- B. Up to 15 points for the creativity of the design of your structure.
- C. Up to 15 points for how creatively you used the materials
- D. Up to 20 points for how well your team works together.

No Hands

Materials:

(Tape to Table)

May be damaged:

30 Cards

5 Mailing Labels

May NOT be damaged and may NOT be
part of the structure:

2 Pairs of Tongs

1 Set of Chopsticks

1 Yardstick

1 Piece of Rope

2 Dowels

The mailing labels may not be attached to the floor.

Instant Challenge

Entry and Advanced Levels

Pick it Up!

Challenge: Your **TASK** is to communicate a list of objects for your team members to pick up.

Time: You will have up to 4 minutes to use your IMAGINATION to create your communication system and then up to 2 minutes to communicate a list of objects for score.

Set-up: In the middle of the room is a table with several objects in a taped grid on it. In addition, there is a screen and a table with materials.

Procedure:

•**Part One** (5 minutes): Use the materials to create your communication system. The objects in the grid may not be part of your team's communication system. There is a practice list of objects to pick up so you can practice communicating in Part One. You should also divide your team into Communicators and Object Pickers. Each team member should be in a group and each group must have at least one team member. You will be warned when you have one minute remaining and 30 seconds remaining in Part One.

•**Part Two** (2 minutes): **No team member may talk during Part Two.** The Communicators will go behind the screen and receive a new list of objects along with a diagram of the table with the grid of objects. The Communicators will bring any materials that are part of their communication system. Communicate the list of objects for score, one object at a time, in the order of the list. The Object Pickers will hold up one object at a time. After the Object Pickers have held up one object, an appraiser will say "next" and the Communicators may communicate a second object. This will continue until ten communications have been made and ten objects have been held up, or until time ends.

Materials:

3 Cans 2 Pieces of Fabric 1 Piece of Foil 6 Dried Noodles 10 Dried Beans
4 Nails 1 Piece of Wood 3 Pieces of Paper 1 Piece of Bubble Wrap

The cans, piece of wood, and nails may not be damaged.

Scoring: You will receive

- A. 5 points (50 points maximum) for each object correctly communicated during Part Two.
- B. Up to 30 points for the creativity of your communication system.
- C. Up to 20 points for how well your team works together.

Pick it Up!

For Appraisers Only:

1. The set-up consists of a screen and a table with objects in a taped grid on it. There is also a table with materials. The exact layout and contents of the grid is described on a separate page.

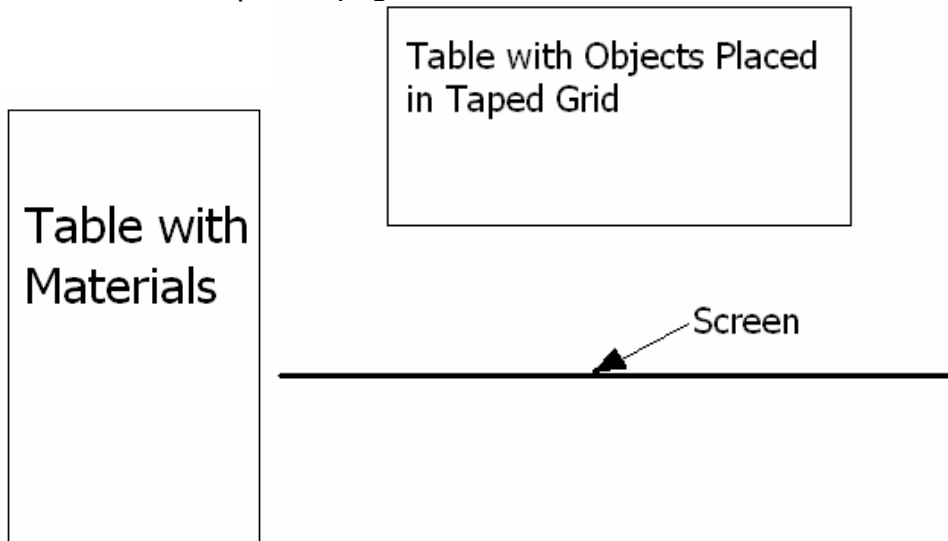

2. Be sure to warn the team when there is 1 minute remaining and 30 seconds remaining in Part One.
3. If a team member talks during Part Two, they should be warned and any points the team may have gained as a result should not be awarded.
4. Make sure that the objects are in the correct place in the grid at the end of Part One.

Pick it Up!

Challenge: Your **TASK** is to communicate a list of objects for your team members to pick up.

Time: You will have up to 4 minutes to use your **IMAGINATION** to create your communication system and then up to 2 minutes to communicate a list of objects for score.

Set-up: In the middle of the room is a table with several objects in a taped grid on it. In addition, there is a screen and a table with materials.

Procedure:

Part One (5 minutes):

- Use the materials to create your communication system.
- The objects in the grid may not be part of your team's communication system.
- There is a practice list of objects to pick up so you can practice communicating in Part One.
- You should also divide your team into Communicators and Object Pickers.
- Each team member should be in a group and each group must have at least one team member.
- You will be warned when you have one minute remaining and 30 seconds remaining in Part One.

Part Two (2 minutes):

- **No team member may talk during Part Two.**
- The Communicators will go behind the screen and receive a new list of objects along with a diagram of the table with the grid of objects.
- The Communicators will bring any materials that are part of their communication system.
- Communicate the list of objects for score, one object at a time, in the order of the list.
- The Object Pickers will hold up one object at a time.
- After the Object Pickers have held up one object, an appraiser will say "next" and the Communicators may communicate a second object.
- This will continue until ten communications have been made and ten objects have been held up, or until time ends.

Scoring: You will receive

- A. 5 points (50 points maximum) for each object correctly communicated during Part Two.
- B. Up to 30 points for the creativity of your communication system.
- C. Up to 20 points for how well your team works together.

Pick it Up!

Materials:

(Tape to Table)

3 Cans

2 Pieces of Fabric

1 Piece of Foil

6 Dried Noodles

10 Dried Beans

4 Nails

1 Piece of Wood

3 Pieces of Paper

1 Piece of Bubble Wrap

The cans, piece of wood, and nails may not be damaged.

Pick it Up!

Practice List of Objects:

1. Candle
2. Magazine
3. Flag
4. Flower
5. Hat
6. Glasses
7. Pencil
8. Paint Brush
9. Box
10. Shoe

Pick it Up!

List of Objects for Challenge:

1. Book
2. Flag
3. Box
4. T-Shirt
5. Rubber Duck
6. Candle
7. Shoe
8. Flower
9. Hat
10. Pencil

Pick it Up!

Diagram of Grid of Objects:

Cup	Hat	Bag	Rubber Duck	Pencil
Shoe	Candle	Magazine	Flag	T-Shirt
Paint Brush	Book	Box	Flower	Glasses

Instant Challenge
Entry and Advanced Levels
Postcard

Challenge: Your **TASK** is to create a postcard from a certain location. Your team should then present a **PERFORMANCE** in which you show what your team did while on vacation at that location.

Time: You will have up to 5 minutes to use your **IMAGINATION** to create your postcard and to practice your **PERFORMANCE**. Your team will then have up to 2 minutes to present your **PERFORMANCE** to the Appraisers.

The Scene: Your team recently went on a vacation. You are writing a postcard home telling about what you did on vacation.

•**Part One** (5 minutes): Use the materials to create your postcard. You should also use this time to plan your **PERFORMANCE**.

•**Part Two** (2 minutes): Present your **PERFORMANCE** to the Appraisers. During your **PERFORMANCE**, tell where you are on vacation and what you did. Be sure to include your postcard in your presentation.

Materials:

8 Colored Markers 1 Piece of Poster Board

The colored markers may NOT be damaged and may not be part of your postcard. A piece of paper and a sharpened pencil also will be available for your team to use as you plan your **PERFORMANCE**.

Scoring: You will receive up to

- A. 20 points for creativity of the location of your vacation.
- B. 20 points for the creativity of what you did while on vacation.
- C. 20 points for the creativity of your postcard.
- D. 20 points for the creativity of your **PERFORMANCE**
- D. 20 points for how well your team works together.

Postcard

For Appraisers Only:

1. The setup consists of a table with materials.

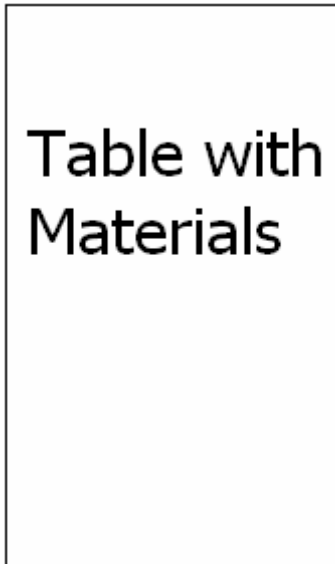

2. The artistic ability of the team is not scored anywhere.

Postcard

Challenge: Your **TASK** is to create a postcard from a certain location. Your team should then present a **PERFORMANCE** in which you show what your team did while on vacation at that location.

Time: You will have up to 5 minutes to use your **IMAGINATION** to create your postcard and to practice your **PERFORMANCE**. Your team will then have up to 2 minutes to present your **PERFORMANCE** to the Appraisers.

The Scene: Your team recently went on a vacation. You are writing a postcard home telling about what you did on vacation.

Part One (5 minutes):

- Use the materials to create your postcard.
- You should also use this time to plan your **PERFORMANCE**.

Part Two (2 minutes):

- Present your **PERFORMANCE** to the Appraisers.
- During your **PERFORMANCE**, tell where you are on vacation and what you did.
- Be sure to include your postcard in your presentation.

Scoring: You will receive up to

- A. 20 points for creativity of the location of your vacation.
- B. 20 points for the creativity of what you did while on vacation.
- C. 20 points for the creativity of your postcard.
- D. 20 points for the creativity of your **PERFORMANCE**
- D. 20 points for how well your team works together.

Postcard

Materials:

(Tape to Table)

8 Colored Markers

1 Piece of Poster Board

The colored markers may NOT be damaged and may not be part of your postcard. A piece of paper and a sharpened pencil also will be available for your team to use as you plan your **PERFORMANCE**.

Instant Challenge
Advanced Level
Rolling Along

Challenge: Your **TASK** is to create a bridge that a ball can be rolled on.

Time: You will have up to 6 minutes to use your **IMAGINATION** to build your bridge and then up to 1 minute to roll the ball for score.

Set-up: In the middle of the room is a taped square. In addition, there is a table with materials.

Procedure:

•**Part One** (6 minutes): Use the materials to build a bridge. You may practice rolling balls in Part One, however the balls rolled will not receive score. In order to proceed to Part Two, you must have a bridge within the taped square by the end of Part One. You will be warned when you have one minute remaining and 30 seconds remaining in Part One. At the end of Part One, the Appraisers will measure the length and height of the bridge.

•**Part Two** (1 minute): Roll balls for score. You will receive points for each ball that rolls from one side of your bridge to the other. You may not attempt to roll each ball more than once. **No team member may touch the bridge during Part Two.**

Materials:

1 Piece of Paper 3 Pencils 3 Chenille Sticks 3 Straws 4 Index Cards
2 Styrofoam Cups 8 Paper Clips 2 Mailing Labels
The mailing labels may NOT be attached to the floor.

Scoring: You will receive

- A. 1 point for each inch (2.5 cm) long your bridge is.
- B. 1 point for each inch (2.5 cm) high your bridge is.
- C. Points for each ball rolled across the bridge.
 - 1 point for the ping pong ball
 - 4 points for the golf ball
 - 10 points for the baseball
 - 15 points for the basketball
- D. Up to 30 points for how creatively you use the materials.
- E. Up to 20 points for how well your team works together.

Rolling Along

For Appraisers Only:

1. The set-up consists of a taped square. There is also a table with materials and balls.

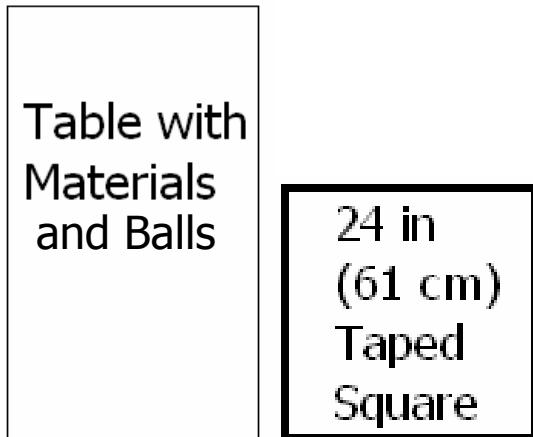

2. Be sure to warn the team when there is 1 minute remaining and 30 seconds remaining in Part One.
3. If a team member touches the bridge during Part Two, they should be warned and any points the team may have gained as a result should not be awarded.
4. One of each type of ball should be available for the team. Each ball should be clearly labeled with a corresponding point value.

Rolling Along

Challenge: Your **TASK** is to create a bridge that a ball can be rolled on.

Time: You will have up to 6 minutes to use your **IMAGINATION** to build your bridge and then up to 1 minute to roll the ball for score.

Set-up: In the middle of the room is a taped square. In addition, there is a table with materials.

Procedure:

Part One (6 minutes):

- Use the materials to build a bridge.
- You may practice rolling balls in Part One, however the balls rolled will not receive score.
- In order to proceed to Part Two, you must have a bridge within the taped square by the end of Part One.
- You will be warned when you have one minute remaining and 30 seconds remaining in Part One.
- At the end of Part One, the Appraisers will measure the length and height of the bridge.

Part Two (1 minute):

- Roll balls for score.
- You will receive points for each ball that rolls from one side of your bridge to the other.
- You may not attempt to roll each ball more than once.
- **No team member may touch the bridge during Part Two.**

Scoring: You will receive

- A. 1 point for each inch (2.5 cm) long your bridge is.
- B. 1 point for each inch (2.5 cm) high your bridge is.
- C. Points for each ball rolled across the bridge.
 - 1 point for the ping pong ball
 - 4 points for the golf ball
 - 10 points for the baseball
 - 15 points for the basketball
- D. Up to 30 points for how creatively you use the materials.
- E. Up to 20 points for how well your team works together.

Rolling Along

Materials:

(Tape to Table)

- 1 Piece of Paper
- 3 Pencils
- 3 Chenille Sticks
- 3 Straws
- 4 Index Cards
- 2 Styrofoam Cups
- 8 Paper Clips
- 2 Mailing Labels

The mailing labels may NOT be attached to the floor.

Instant Challenge
Entry and Advanced Levels
Round Trip

Challenge: Your **TASK** is to create a device that will travel from one taped circle to another.

Time: You will have up to 5 minutes to use your IMAGINATION to create your traveling device and then up to 2 minutes to travel to various circles for score.

Set-up: In the middle of the room is a big taped square with ten taped circles inside it. In addition, there is a table with materials.

Procedure:

•**Part One** (5 minutes): Use the materials to create a traveling device. There is a practice list of circles to visit so you can practice traveling in Part One. In order to proceed to Part Two, you must have a traveling device within the taped square by the end of Part One. You will be warned when you have one minute remaining and 30 seconds remaining in Part One.

•**Part Two** (2 minutes): You will receive a new list of circles to visit. The device should travel through these circles for score. In order to receive score, the device must cross into each taped circle in the order on the list. **No team member may go within the taped square during Part Two.**

Materials:

5 Straws	1 Piece of Paper	1 Piece of String	1 Pencil	3 Mailing Labels
1 Envelope	1 Styrofoam Cup	2 Chenille Sticks	3 cards	3 Clothes Pins

Scoring: You will receive

- A. 5 points (50 points maximum) for each circle your device travels through
- B. Up to 30 points for how creatively you use the materials.
- C. Up to 20 points for how well your team works together.

Round Trip

For Appraisers Only:

1. The set-up consists of a big taped square with ten taped circles inside it. There is also a table with materials.

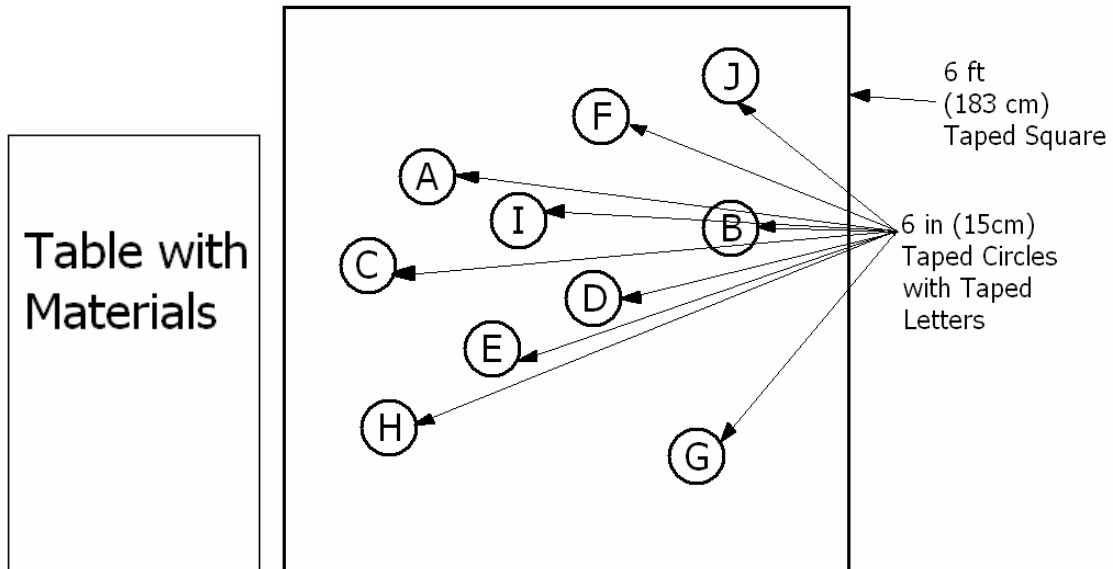

2. Be sure to warn the team when there is 1 minute remaining and 30 seconds remaining in Part One.
3. If a team member goes within the taped square during Part Two, they should be warned and any points the team may have gained as a result should not be awarded.

Round Trip

Challenge: Your **TASK** is to create a device that will travel from one taped circle to another.

Time: You will have up to 5 minutes to use your **IMAGINATION** to create your traveling device and then up to 2 minutes to travel to various circles for score.

Set-up: In the middle of the room is a big taped square with ten taped circles inside it. In addition, there is a table with materials.

Procedure:

Part One (5 minutes):

- Use the materials to create a traveling device.
- There is a practice list of circles to visit so you can practice traveling in Part One.
- In order to proceed to Part Two, you must have a traveling device within the taped square by the end of Part One.
- You will be warned when you have one minute remaining and 30 seconds remaining in Part One.

Part Two (2 minutes):

- You will receive a new list of circles to visit.
- The device should travel through these circles for score.
- In order to receive score, the device must cross into each taped circle in the order on the list.
- **No team member may go within the taped square during Part Two.**

Scoring: You will receive

- A. 5 points (50 points maximum) for each circle your device travels through
- B. Up to 30 points for how creatively you use the materials.
- C. Up to 20 points for how well your team works together.

Round Trip

Materials:

(Tape to Table)

5 Straws

1 Piece of Paper

1 Piece of String

1 Styrofoam Cup

3 Mailing Labels

1 Envelope

3 Cards

2 Chenille Sticks

1 Pencil

3 Clothes Pins

Practice List of Circles:

1. A
2. C
3. G
4. I
5. B
6. E
7. D
8. H
9. J
10. F

Round Trip

List of Circles for Challenge:

1. F
2. E
3. J
4. B
5. G
6. C
7. A
8. H
9. I
10. D

Instant Challenge
Entry and Advanced Levels
Sculpture Story

Challenge: Your **TASK** is to create a sculpture without touching it. Your team should then present a **PERFORMANCE** in which you tell a story about the sculpture.

Time: You will have up to 5 minutes to use your **IMAGINATION** to create your sculpture and to practice your **PERFORMANCE**. Your team will then have up to 2 minutes to present your **PERFORMANCE** to the Appraisers.

The Scene: Your team has just created a sculpture. What is the story behind it?

•**Part One** (5 minutes): Use the materials to create a sculpture. **No team member may touch the materials that may be damaged during Part One.** You should also use this time to plan your **PERFORMANCE**.

•**Part Two** (2 minutes): Present your **PERFORMANCE** to the Appraisers. During your **PERFORMANCE**, you should tell a story about your sculpture.

Materials:

(May be damaged)

1 Ball of Clay 3 Foam Balls 4 Toothpicks 3 Marshmallows 5 Feathers

(May NOT be damaged and may NOT be part of the sculpture)

2 Pairs of Tongs 1 Set of Chopsticks 1 Yardstick 1 Piece of Rope 2 Dowels

A piece of paper and a sharpened pencil also will be available for your team to use as you plan and present your **PERFORMANCE**.

Scoring: You will receive up to

- A. 20 points for the creativity of your sculpture.
- B. 30 points for how creatively you use the materials.
- C. 30 points for the creativity of your story.
- D. 20 points for how well your team works together.

Sculpture Story

For Appraisers Only:

1. The setup consists of a table with materials.

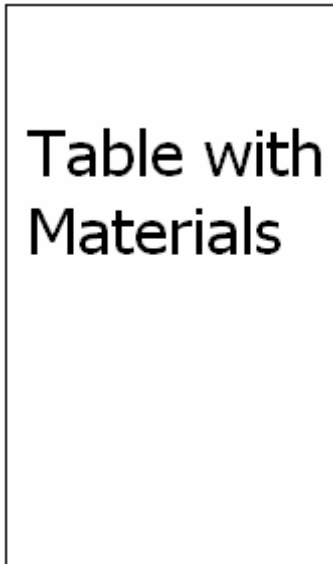

2. If a team member touches any of the materials that may be altered during Part One, they should be warned and no points should be awarded that they may have gained as a result.
3. When scoring the team on creativity of use of materials, consider both how they use the materials that may be altered and how they use the ones that may not be altered.

Sculpture Story

Challenge: Your **TASK** is to create a sculpture without touching it. Your team should then present a **PERFORMANCE** in which you tell a story about the sculpture.

Time: You will have up to 5 minutes to use your **IMAGINATION** to create your sculpture and to practice your **PERFORMANCE**. Your team will then have up to 2 minutes to present your **PERFORMANCE** to the Appraisers.

The Scene: Your team has just created a sculpture. What is the story behind it?

Part One (5 minutes):

- Use the materials to create a sculpture.
- **No team member may touch the materials that may be damaged during Part One.**
- You should also use this time to plan your **PERFORMANCE**.

Part Two (2 minutes):

- Present your **PERFORMANCE** to the Appraisers.
- During your **PERFORMANCE**, you should tell a story about your sculpture.

Scoring: You will receive up to

- A. 20 points for the creativity of your sculpture.
- B. 30 points for how creatively you use the materials.
- C. 30 points for the creativity of your story.
- D. 20 points for how well your team works together.

Sculpture Story

Materials:

(Tape to Table)

May be damaged:

- 1 Ball of Clay
- 3 Foam Balls
- 4 Toothpicks
- 3 Marshmallows
- 5 Feathers

May NOT be damaged and may NOT be part of the sculpture:

- 2 Pairs of Tongs
- 1 Set of Chopsticks
- 1 Yardstick
- 1 Piece of Rope
- 2 Dowels

A piece of paper and a sharpened pencil also will be available for your team to use as you plan and present your **PERFORMANCE**.

Instant Challenge
Entry and Advanced Levels
Shapes and Colors

Challenge: Your **TASK** is to communicate which colored shapes should be placed in taped squares.

Time: You will have up to 5 minutes to use your **IMAGINATION** to create a method of communication and then up to 2 minutes to communicate a list of colored shapes for score.

Set-up: In the middle of the room is a screen and a table with colored shapes and taped squares. In addition, there is a table with materials.

Procedure:

•**Part One** (5 minutes): Use the materials to create your communication system. The colored shapes may not be part of your team's communication system. There is a practice list of colored shapes to place in squares so you can practice communicating in Part One. You should also divide your team into Communicators and Shape Choosers. Each team member should be in a group and each group must have at least one team member. You will be warned when you have one minute remaining and 30 seconds remaining in Part One.

•**Part Two** (2 minutes): **No team member may talk during Part Two.** The Communicators will go behind the screen and receive a new list of colored shapes. The Communicators will bring any materials that are part of their communication system. Communicate the list of colored shapes for. The Shape Choosers will place one colored shape in each taped square. At any point during Part Two, one Communicator may come out from behind the screen and look at the shapes in the squares without communicating. That communicator may then move behind the screen again and continue communicating.

Materials:

1 Can 3 Rubber Bands 2 Marbles 1 Plastic Container 1 Dowel 1 Rubber Duck
No materials may be damaged.

Scoring: You will receive

- A. 5 points (25 points maximum) for each taped square with the correct color of shape inside at the end of Part Two.
- B. 5 points (25 points maximum) for each taped square with the correct shape inside it at the end of Part Two.
- C. Up to 15 points for the creativity of your method of communication.
- D. Up to 15 points for how creatively you use the materials
- E. Up to 20 points for how well your team works together.

Shapes and Colors

For Appraisers Only:

1. The set-up consists of a screen, a table with colored shapes, and 5 taped squares. There is also a table with materials. The colored shapes should be made of craft foam.

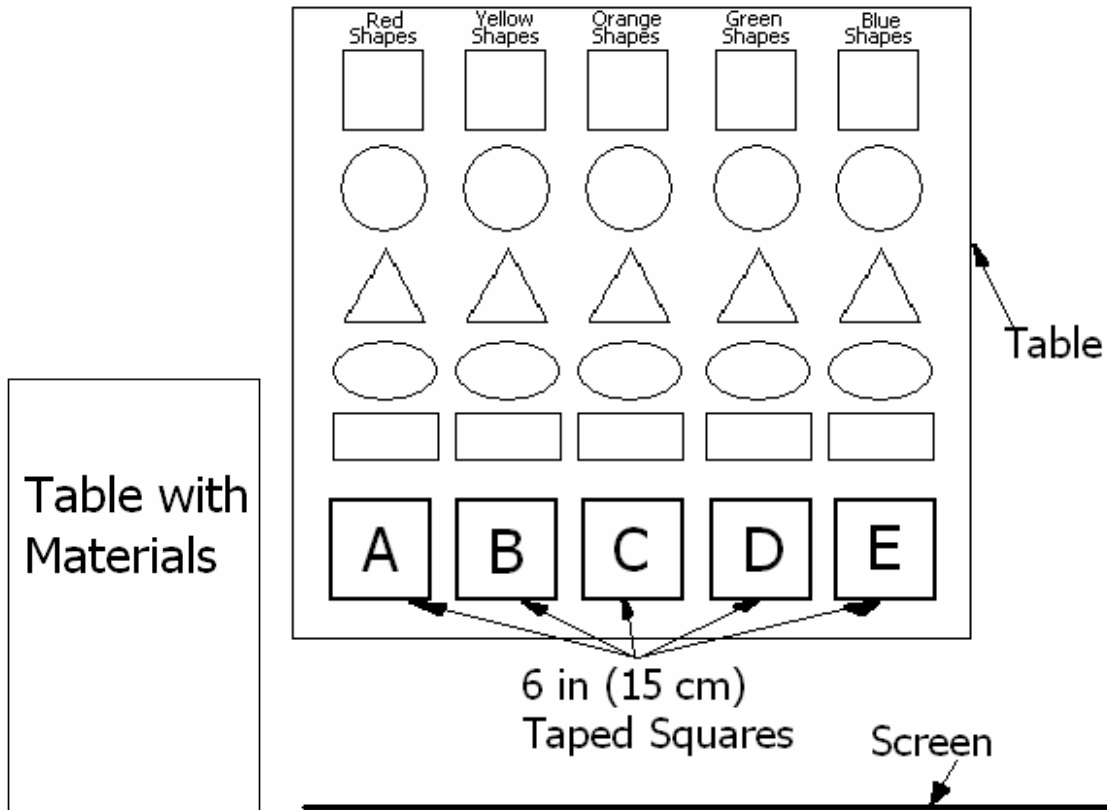

2. Be sure to warn the team when there is 1 minute remaining and 30 seconds remaining in Part One.

3. If a team member talks during Part Two (even to a member of his or her own group), they should be warned and any points the team may have gained as a result should not be awarded.

Shapes and Colors

Challenge: Your **TASK** is to communicate which colored shapes should be placed in taped squares.

Time: You will have up to 5 minutes to use your **IMAGINATION** to create a method of communication and then up to 2 minutes to communicate a list of colored shapes for score.

Set-up: In the middle of the room is a screen and a table with colored shapes and taped squares. In addition, there is a table with materials.

Procedure:

Part One (5 minutes):

- Use the materials to create your communication system.
- The colored shapes may not be part of your team's communication system.
- There is a practice list of colored shapes to place in squares so you can practice communicating in Part One.
- You should also divide your team into Communicators and Shape Choosers.
- Each team member should be in a group and each group must have at least one team member.
- You will be warned when you have one minute remaining and 30 seconds remaining in Part One.

Part Two (2 minutes):

- **No team member may talk during Part Two.**
- The Communicators will go behind the screen and receive a new list of colored shapes.
- The Communicators will bring any materials that are part of their communication system.
- Communicate the list of colored shapes for.
- The Shape Choosers will place one colored shape in each taped square.
- At any point during Part Two, one Communicator may come out from behind the screen and look at the shapes in the squares without communicating.
- That communicator may then move behind the screen again and continue communicating.

Scoring: You will receive

- A. 5 points (25 points maximum) for each taped square with the correct color of shape inside at the end of Part Two.
- B. 5 points (25 points maximum) for each taped square with the correct shape inside it at the end of Part Two.
- C. Up to 15 points for the creativity of your method of communication.
- D. Up to 15 points for how creatively you use the materials
- E. Up to 20 points for how well your team works together.

Shapes and Colors

Materials:

(Tape to Table)

1 Can

3 Rubber Bands

2 Marbles

1 Plastic Container

1 Dowel

1 Rubber Duck

No materials may be damaged.

Practice List of Colored Shapes:

- A. Orange Circle
- B. Red Square
- C. Blue Triangle
- D. Green Oval
- E. Yellow Square

List of Colored Shapes for Challenge:

- A. Red Rectangle
- B. Green Rectangle
- C. Orange Oval
- D. Blue Circle
- E. Green Triangle

Instant Challenge
Entry Level
Show Some Restraint

Challenge: Your **TASK** is to create a hanging device that will not break when it is dropped and that will hold as many marbles as possible.

Time: You will have up to 5 minutes to use your IMAGINATION to create your device, up to 30 seconds to drop it for score, and up to 2 minutes to add marbles for score.

Set-up: In the middle of the room is a table with a peg. In addition, there is a table with materials.

Procedure:

•**Part One** (5 minutes): Use the materials to create your hanging device. The device must be attached to the peg. You may practice dropping your device in Part One, however this will not receive score in Part One. In order to proceed to Part Two, you must have a device attached to the peg by the end of Part One. You will be warned when you have one minute remaining and 30 seconds remaining in Part One.

•**Part Two** (30 seconds): Drop your device for score. A team member should lift the device above the peg and drop it. At the end of Part Two, the Appraisers will measure the distance between the bottom of the device and the peg. This measurement will only receive score if the device is not touching the floor at the end of Part Two. In order to proceed to Part Three your device may not be touching the floor at the end of Part Two.

•**Part Three** (2 minutes): Add marbles to your device for score. In order to receive score, the device must hold a marble without touching the floor and without a team member touching it for ten seconds.

Materials:

1 Piece of String	1 Piece of Foil	3 Straws	5 Mailing Labels	Scissors
1 Piece of Paper	2 Rubber Bands	3 Cards	2 Chenille Sticks	5 Marbles

The mailing labels may NOT be attached to the peg or the marbles. The scissors may not be altered and may not be part of your device.

Scoring: You will receive

- A. 1 point for each inch (2.5 cm) the device is from the peg.
- B. 5 points (25 points maximum) for each marble held by your device.
- C. Up to 30 points for how creatively you use the materials.
- D. Up to 20 points for how well your team works together.

Show Some Restraint
For Appraisers Only:

1. The set-up consists of a table with a peg. The peg should be as close to 26 inches (66 cm) from the floor as possible. The peg can be a pencil taped to the table. There is also a table with materials.

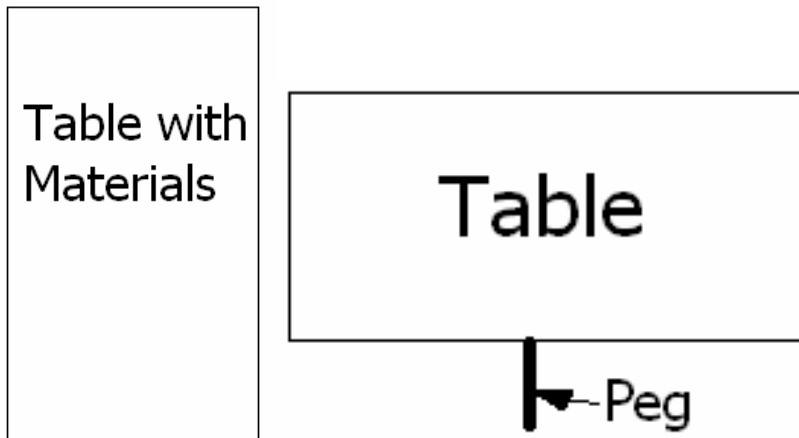

2. Be sure to warn the team when there is 1 minute remaining and 30 seconds remaining in Part One.
3. To receive score for A and B, the device and marbles may not be touching the floor.

Show Some Restraint

Challenge: Your **TASK** is to create a hanging device that will not break when it is dropped and that will hold as many marbles as possible.

Time: You will have up to 5 minutes to use your **IMAGINATION** to create your device, up to 30 seconds to drop it for score, and up to 2 minutes to add marbles for score.

Set-up: In the middle of the room is a table with a peg. In addition, there is a table with materials.

Procedure:

Part One (5 minutes):

- Use the materials to create your hanging device.
- The device must be attached to the peg.
- You may practice dropping your device in Part One, however this will not receive score in Part One.
- In order to proceed to Part Two, you must have a device attached to the peg by the end of Part One.
- You will be warned when you have one minute remaining and 30 seconds remaining in Part One.

Part Two (30 seconds):

- Drop your device for score.
- A team member should lift the device above the peg and drop it.
- At the end of Part Two, the Appraisers will measure the distance between the bottom of the device and the peg.
- This measurement will only receive score if the device is not touching the floor at the end of Part Two.
- In order to proceed to Part Three your device may not be touching the floor at the end of Part Two.

Part Three (2 minutes):

- Add marbles to your device for score.
- In order to receive score, the device must hold a marble without touching the floor and without a team member touching it for ten seconds.

Scoring: You will receive

- A. 1 point for each inch (2.5 cm) the device is from the peg.
- B. 5 points (25 points maximum) for each marble held by your device.
- C. Up to 30 points for how creatively you use the materials.
- D. Up to 20 points for how well your team works together.

Show Some Restraint

Materials:

(Tape to Table)

1 Piece of String

1 Piece of Foil

3 Straws

5 Mailing Labels

Scissors

1 Piece of Paper

2 Rubber Bands

3 Cards

2 Chenille Sticks

5 Marbles

The mailing labels may NOT be attached to them peg or the marbles. The scissors may not be altered and may not be part of your device.

Instant Challenge
Advanced Level
Show Some Restraint

Challenge: Your **TASK** is to create a device that will hold marbles close to the floor and will not break when the marbles are dropped.

Time: You will have up to 5 minutes to use your IMAGINATION to create your device and then up to 2 minutes to drop it for score.

Set-up: In the middle of the room is a table with a peg. In addition, there is a table with materials.

Procedure:

•**Part One** (5 minutes): Use the materials to create your marble-holding device. The device must be attached to the peg. The device should hold marbles as close to the floor as possible. You may practice dropping your device in Part One, however this will not receive score in Part One. In order to proceed to Part Two, you must have a device attached to the peg by the end of Part One. You will be warned when you have one minute remaining and 30 seconds remaining in Part One.

•**Part Two** (2 minutes): Drop your device for score. A team member should lift the device with the marbles above the peg and drop it. **No team member may touch the device or the marbles after the device is dropped during Part Two.** At the end of Part Two, the Appraisers will measure the distance between the marbles in the device and the peg. This measurement will only receive score if the device and the marbles are not touching the floor at the end of Part Two. Likewise, the number of marbles held will only receive score if they are contained by the device and neither the marbles nor the device is touching the floor at the end of Part Two.

Materials:

1 Piece of String	1 Piece of Foil	3 Straws	5 Mailing Labels	Scissors
1 Piece of Paper	2 Rubber Bands	3 Cards	2 Chenille Sticks	5 Marbles

The mailing labels may NOT be attached to the peg or the marbles. The scissors may not be altered and may not be part of your device.

Scoring: You will receive

- A. 5 points (25 points maximum) for each marble held by your device.
- B. 1 point for each inch (2.5 cm) the device is from the peg.
- C. Up to 30 points for how creatively you use the materials.
- D. Up to 20 points for how well your team works together.

Show Some Restraint
For Appraisers Only:

1. The set-up consists of a table with a peg. The peg should be as close to 25 inches (63.5 cm) from the floor as possible. The peg can be a pencil taped to the table. There is also a table with materials.

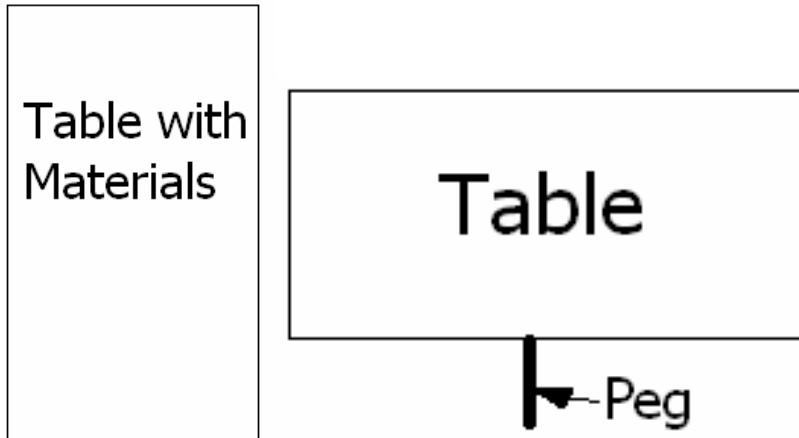

2. Be sure to warn the team when there is 1 minute remaining and 30 seconds remaining in Part One.
3. If a team member touches the device or the marbles after the device is dropped during Part Two, they should be warned and any points the team may have gained as a result should not be awarded.
4. To receive score for A and B, the device and marbles may not be touching the floor.
5. The number of marbles held should be the number of marbles that are in the device at the end of Part Two.

Show Some Restraint

Challenge: Your **TASK** is to create a device that will hold marbles close to the floor and will not break when the marbles are dropped.

Time: You will have up to 5 minutes to use your **IMAGINATION** to create your device and then up to 2 minutes to drop it for score.

Set-up: In the middle of the room is a table with a peg. In addition, there is a table with materials.

Procedure:

Part One (5 minutes):

- Use the materials to create your marble-holding device.
- The device must be attached to the peg.
- The device should hold marbles as close to the floor as possible.
- You may practice dropping your device in Part One, however this will not receive score in Part One.
- In order to proceed to Part Two, you must have a device attached to the peg by the end of Part One.
- You will be warned when you have one minute remaining and 30 seconds remaining in Part One.

Part Two (2 minutes):

- Drop your device for score.
- A team member should lift the device with the marbles above the peg and drop it.
- **No team member may touch the device or the marbles after the device is dropped during Part Two.**
- At the end of Part Two, the Appraisers will measure the distance between the marbles in the device and the peg.
- This measurement will only receive score if the device and the marbles are not touching the floor at the end of Part Two.
- Likewise, the number of marbles held will only receive score if they are contained by the device and neither the marbles nor the device is touching the floor at the end of Part Two.

Scoring: You will receive

- A. 5 points (25 points maximum) for each marble held by your device.
- B. 1 point for each inch (2.5 cm) the device is from the peg.
- C. Up to 30 points for how creatively you use the materials.
- D. Up to 20 points for how well your team works together.

Show Some Restraint

Materials:

(Tape to Table)

1 Piece of String

1 Piece of Foil

3 Straws

5 Mailing Labels

Scissors

1 Piece of Paper

2 Rubber Bands

3 Cards

2 Chenille Sticks

5 Marbles

The mailing labels may NOT be attached to them peg or the marbles. The scissors may not be altered and may not be part of your device.

Instant Challenge
Entry and Advanced Levels
Silent Movie

Challenge: Present a **PERFORMANCE** in which your team acts out a silent movie with subtitles.

For the purposes of this challenge, “subtitles” are dialogue that is written out for the audience to read.

Time: You will have up to 5 minutes to use your **IMAGINATION** to plan your **PERFORMANCE**. You then will have up to 2 minutes to present your **PERFORMANCE** to the Appraisers.

The Scene: In silent movies there is no sound. Instead of listening to the dialogue, it is written on the screen for the audience to read.

- **Part One** (5 minutes): Create a silent **PERFORMANCE** where you use subtitles instead of talking.
- **Part Two** (2 minutes): Present your **PERFORMANCE** to the appraisers. **No team member may talk during Part Two.**

Materials:

You will be given two sheets of poster board, a pair of scissors, and 4 markers to use to make your subtitles in Part One. All props should be imaginary. A piece of paper and a pencil will be available for your team to use as you plan and present your **PERFORMANCE**.

Scoring: You will receive up to:

- A. 25 points for the creativity of your **PERFORMANCE**.
- B. 30 points for the creativity of your subtitles.
- C. 25 points for how well you tell a story in your **PERFORMANCE**.
- D. 20 points for how well your team works together.

Silent Movie

Challenge: Present a **PERFORMANCE** in which your team acts out a silent movie with subtitles.

For the purposes of this challenge, “subtitles” are dialogue that is written out for the audience to read.

Time: You will have up to 5 minutes to use your **IMAGINATION** to plan your **PERFORMANCE**. You then will have up to 2 minutes to present your **PERFORMANCE** to the Appraisers.

The Scene: In silent movies there is no sound. Instead of listening to the dialogue, it is written on the screen for the audience to read.

Part One (5 minutes):

- Create a silent **PERFORMANCE** where you use subtitles instead of talking.

Part Two (2 minutes):

- Present your **PERFORMANCE** to the appraisers.
- **No team member may talk during Part Two.**

Materials:

You will be given two sheets of poster board, a pair of scissors, and 4 markers to use to make your subtitles in Part One. All props should be imaginary. A piece of paper and a pencil will be available for your team to use as you plan and present your **PERFORMANCE**.

Scoring: You will receive up to:

- A. 25 points for the creativity of your **PERFORMANCE**.
- B. 30 points for the creativity of your subtitles.
- C. 25 points for how well you tell a story in your **PERFORMANCE**.
- D. 20 points for how well your team works together.

Instant Challenge
Entry and Advanced Levels
Sort it Out

Challenge: Your **TASK** is to sort colored craft sticks into containers without touching them.

Time: You will have up to 5 minutes to use your IMAGINATION to create one or more sorters and then up to 1 minute to sort craft sticks for score.

Set-up: In the middle of the room is a taped circle with craft sticks inside, surrounded by containers. In addition, there is a table with materials.

Procedure:

•**Part One** (5 minutes): Use the materials to build one or more sorters. You may practice sorting in Part One, however the sticks sorted will not receive score. You will be warned when you have one minute remaining and 30 seconds remaining in Part One.

•**Part Two** (1 minute): Sort the sticks for score. **No team member may touch the craft sticks during Part Two.**

Materials:

1 Yardstick 3 Rubber Bands 1 Pair of Chopsticks 5 Cards 5 Mailing Labels
4 Paper Clips 2 Plastic Forks 3 Pieces of String 3 Pencils 1 Piece of Foil

The mailing labels may NOT be attached to the yardstick. The yardstick may not be damaged.

Scoring: You will receive

- A. 5 points (50 points maximum) for each stick correctly sorted in Part Two.
- B. Up to 30 points for how creatively you used the materials
- C. Up to 20 points for how well your team works together.

Sort it Out

For Appraisers Only:

1. The set-up consists of 5 containers labeled with colors and ten colored sticks in a taped circle. There is also a table with materials. There should be enough room to walk between the containers and the taped circle.

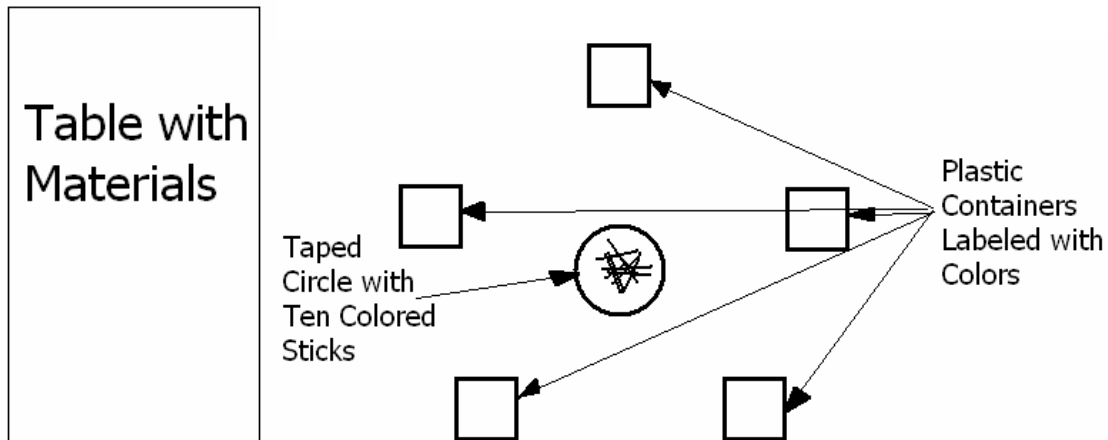

2. Be sure to warn the team when there is 1 minute remaining and 30 seconds remaining in Part One.
3. If a team member touches a stick during Part Two, they should be warned and any points the team may have gained as a result should not be awarded.
4. There should be two sticks of each color within the taped circle.

Sort it Out

Challenge: Your **TASK** is to sort colored craft sticks into containers without touching them.

Time: You will have up to 5 minutes to use your **IMAGINATION** to create one or more sorters and then up to 1 minute to sort craft sticks for score.

Set-up: In the middle of the room is a taped circle with craft sticks inside, surrounded by containers. In addition, there is a table with materials.

Procedure:

Part One (5 minutes):

- Use the materials to build one or more sorters.
- You may practice sorting in Part One, however the sticks sorted will not receive score.
- You will be warned when you have one minute remaining and 30 seconds remaining in Part One.

Part Two (1 minute):

- Sort the sticks for score.
- No team member may touch the craft sticks during Part Two.

Scoring: You will receive

- A. 5 points (50 points maximum) for each stick correctly sorted in Part Two.
- B. Up to 30 points for how creatively you used the materials
- C. Up to 20 points for how well your team works together.

Sort it Out

Materials:

(Tape to Table)

- 1 Yardstick
- 3 Rubber Bands
- 1 Pair of Chopsticks
- 5 Cards
- 5 Mailing Labels
- 4 Paper Clips
- 2 Plastic Forks
- 3 Pieces of String
- 3 Pencils
- 1 Piece of Foil

The mailing labels may NOT be attached to the yardstick. The yardstick may not be damaged.

Instant Challenge
Entry and Advanced Levels
Splat!

Challenge: Your **TASK** is to create a structure that is as tall as possible after it has been dropped.

Time: You will have up to 5 minutes to use your IMAGINATION to build your tower and then up to 1 minute to drop it for score.

Set-up: In the middle of the room is a taped square. In addition, there is a table with materials.

Procedure:

•**Part One** (5 minutes): Use the materials to build your structure. You may practice dropping it in Part One, however these drops will not receive score. In order to proceed to Part Two, you must have a structure within the taped square by the end of Part One. You will be warned when you have one minute remaining and 30 seconds remaining in Part One.

•**Part Two** (1 minute): Drop your structure into the taped square for score. You must drop your structure from a height of at least three feet (91 cm). Before you drop your structure, an appraiser will measure the distance between your structure and the floor. **No team member may go within the taped square during Part Two.** At the end of Part Two, the Appraisers will measure the height of the tallest part of your structure.

Materials:

2 Pencils 3 Index Cards 3 Pieces of String 4 Mailing Labels 3 Straws
1 Piece of Foil 4 Paper Clips

Scoring: You will receive

- A. 10 points if you have a structure within the taped square at the end of Part One.
- B. 3 points for each inch tall your structure is at the end of Part Two.
- C. Up to 20 points for the design of your structure.
- D. Up to 20 points for how creatively you use the materials
- E. Up to 20 points for how well your team works together.

Splat!

For Appraisers Only:

1. The set-up consists of a taped square. There is also a table with materials.

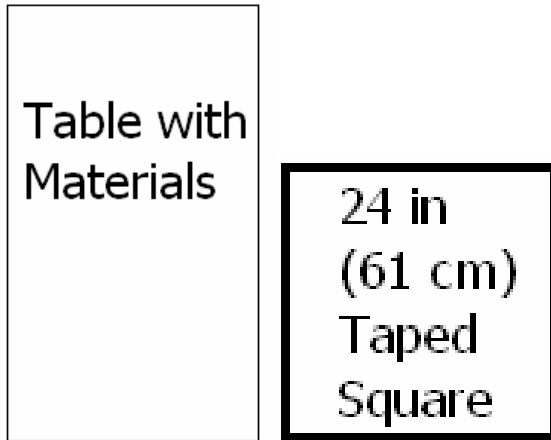

2. Be sure to warn the team when there is 1 minute remaining and 30 seconds remaining in Part One.
3. If a team member goes within the taped square during Part Two, they should be warned and any points the team may have gained as a result should not be awarded.

Splat!

Challenge: Your **TASK** is to create a structure that is as tall as possible after it has been dropped.

Time: You will have up to 5 minutes to use your **IMAGINATION** to build your tower and then up to 1 minute to drop it for score.

Set-up: In the middle of the room is a taped square. In addition, there is a table with materials.

Procedure:

Part One (5 minutes):

- Use the materials to build your structure.
- You may practice dropping it in Part One, however these drops will not receive score.
- In order to proceed to Part Two, you must have a structure within the taped square by the end of Part One.
- You will be warned when you have one minute remaining and 30 seconds remaining in Part One.

Part Two (1 minute):

- Drop your structure into the taped square for score.
- You must drop your structure from a height of at least three feet (91 cm).
- Before you drop your structure, an appraiser will measure the distance between your structure and the floor.
- **No team member may go within the taped square during Part Two.**
- At the end of Part Two, the Appraisers will measure the height of the tallest part of your structure.

Scoring: You will receive

- A. 10 points if you have a structure within the taped square at the end of Part One.
- B. 3 points for each inch tall your structure is at the end of Part Two.
- C. Up to 20 points for the design of your structure.
- D. Up to 20 points for how creatively you use the materials
- E. Up to 20 points for how well your team works together.

Splat!

Materials:

(Tape to Table)

2 Pencils

3 Index Cards

3 Pieces of String

4 Mailing Labels

3 Straws

1 Piece of Foil

4 Paper Clips

Instant Challenge
Entry and Advanced Levels
Squared Away

Challenge: Your **TASK** is to connect as many taped squares as possible.

Time: You will have up to 7 minutes to use your **IMAGINATION** to use the materials to connect taped squares for score.

Set-up: In the middle of the room are several taped squares with numbers in them. In addition, there is a table with materials.

Procedure:

Use the materials to connect taped squares. In order to receive score, the squares must be connected by one length of materials, starting at the square marked "0". If the connector has more than two ends (one of them is in the "0" square), only the highest scoring set of connected squares will receive score. The connector must not have a break in it, or the square(s) after the break will not receive score. You will be warned when you have one minute remaining and 30 seconds remaining in Part One. When time ends, no team member may touch the materials while the appraisers decide which squares will receive score.

Materials:

1 Piece of Foil	3 Mailing Labels	1 Piece of Paper	1 Piece of String
1 Pencil	2 Chenille Sticks	1 Set of Chopsticks	5 Paper Clips

The mailing labels may NOT be attached to the floor.

Scoring: You will receive

- A. The point values of each taped square you connect (50 points maximum)
- B. Up to 30 points for how creatively you use the materials.
- C. Up to 20 points for how well your team works together.

Squared Away
For Appraisers Only:

1. The set-up consists of 15 taped squares. There is also a table with materials.

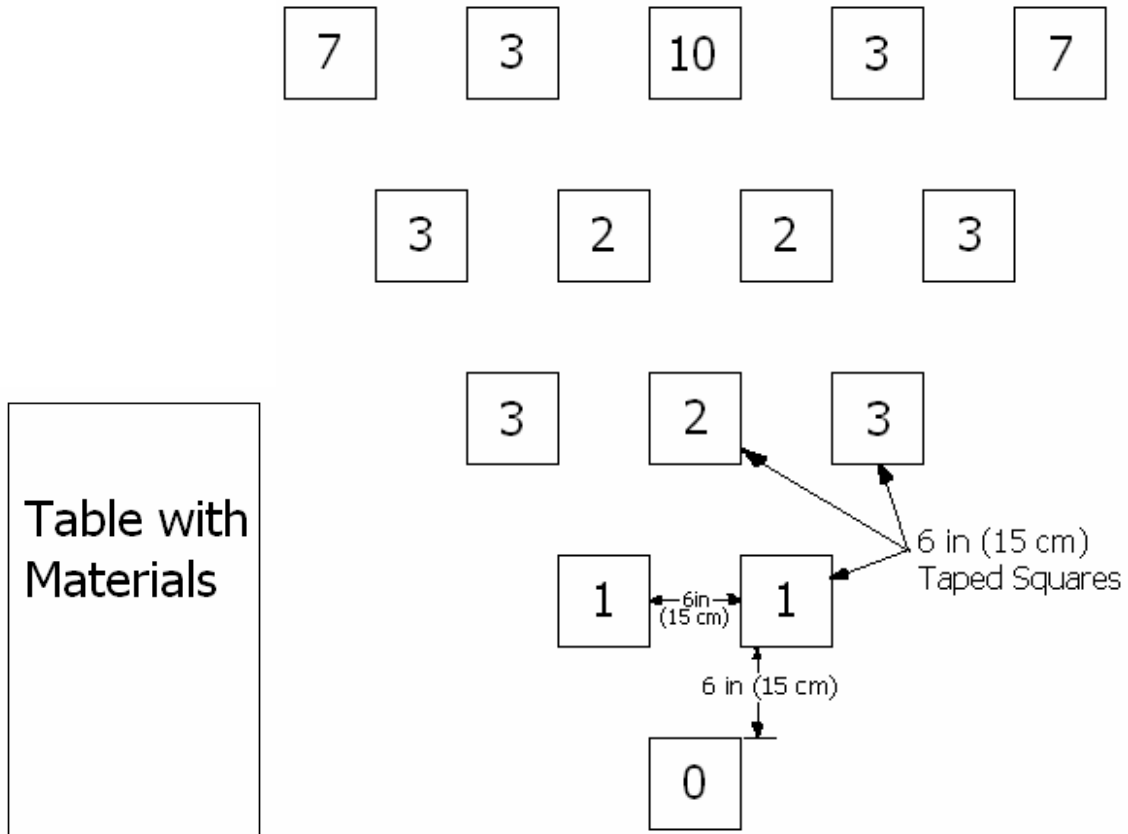

2. Be sure to warn the team when there is 1 minute remaining and 30 seconds remaining in Part One.

Squared Away

Challenge: Your **TASK** is to connect as many taped squares as possible.

Time: You will have up to 7 minutes to use your **IMAGINATION** to use the materials to connect taped squares for score.

Set-up: In the middle of the room are several taped squares with numbers in them. In addition, there is a table with materials.

Procedure:

- Use the materials to connect taped squares.
- In order to receive score, the squares must be connected by one length of materials, starting at the square marked "0".
- If the connector has more than two ends (one of them is in the "0" square), only the highest scoring path of connected squares will receive score.
- The connector must not have a break in it, or the square(s) after the break will not receive score.
- You will be warned when you have one minute remaining and 30 seconds remaining in Part One.
- When time ends, no team member may touch the materials while the appraisers decide which squares will receive score.

Scoring: You will receive

- A. The point values of each taped square you connect (50 points maximum)
- B. Up to 30 points for how creatively you use the materials.
- C. Up to 20 points for how well your team works together.

Squared Away

Materials:

(Tape to Table)

- 1 Piece of Foil
- 3 Mailing Labels
- 1 Piece of Paper
- 1 Piece of String
- 1 Pencil
- 2 Chenille Sticks
- 1 Set of Chopsticks
- 5 Paper Clips

The mailing labels may NOT be attached to the floor.

Instant Challenge
Entry Level
Still as a Statue

Challenge: Present a **PERFORMANCE** in which one or more members of your team stands perfectly still.

Time: You will have up to 5 minutes to use your **IMAGINATION** to plan your **PERFORMANCE**. You then will have up to 5 minutes to present your **PERFORMANCE** to the Appraisers.

The Scene: Someone is standing still as a statue, but why?

- **Part One** (5 minutes): Create a **PERFORMANCE** where one or more of your team members stands perfectly still. Use props creatively to make the performance interesting.
- **Part Two** (2 minutes): Present your **PERFORMANCE** to the appraisers. During your performance, you should integrate one or more people standing still as much as possible. Be sure you tell a clear story.

Materials:

(May NOT be damaged)

1 Trash Can 1 Broom 3 Cups 2 Books 1 Rubber Duck

A piece of paper and a pencil will be available for your team to use as you plan and present your **PERFORMANCE**.

Scoring: You will receive up to:

- 10 points (50 points Maximum) for how creatively you use each of the props.
- 15 points for how well you integrate one or more team members standing still.
- 15 points for how well you tell a clear story.
- 20 points for how well your team works together.

Still as a Statue

Challenge: Present a **PERFORMANCE** in which one or more members of your team stands perfectly still.

Time: You will have up to 5 minutes to use your **IMAGINATION** to plan your **PERFORMANCE**. You then will have up to 5 minutes to present your **PERFORMANCE** to the Appraisers.

The Scene: Someone is standing still as a statue, but why?

Part One (5 minutes):

- Create a **PERFORMANCE** where one or more of your team members stands perfectly still.
- Use props creatively to make the performance interesting.

Part Two (2 minutes):

- Present your **PERFORMANCE** to the appraisers.
- During your performance, you should integrate one or more people standing still as much as possible.
- Be sure you tell a clear story.

Materials:

(May NOT be damaged)

1 Trash Can 1 Broom 3 Cups 2 Books 1 Rubber Duck

A piece of paper and a pencil will be available for your team to use as you plan and present your **PERFORMANCE**.

Scoring: You will receive up to:

- 10 points (50 points Maximum) for how creatively you use each of the props.
- 15 points for how well you integrate one or more team members standing still.
- 15 points for how well you tell a clear story.
- 20 points for how well your team works together.

Instant Challenge
Entry and Advanced Levels
Suspension Bridge

Challenge: Your **TASK** is to create a bridge and hang weights from it.

Time: You will have up to 5 minutes to use your **IMAGINATION** to create your bridge and then up to 2 minutes to hang weights for score.

Set-up: In the middle of the room are two tables. In addition, there is a table with materials.

Procedure:

•**Part One** (5 minutes): Use the materials to create a bridge between the tables. You may practice hanging weights in Part One, however the weights added will not receive score. In order to proceed to Part Two, you must have a bridge between the two tables at the end of Part One. You will be warned when you have one minute remaining and 30 seconds remaining in Part One.

•**Part Two** (2 minutes): Hang weights for score. **No team member may touch the bridge during Part Two.** In order for a weight to be scored, it must be held for ten seconds without any team member touching the bridge.

Materials:

2 Pieces of Paper 4 Straws 1 Pencil 3 Mailing Labels 1 Piece of Foil
3 Pieces of String 3 Cards 4 Nails

The mailing labels may NOT be attached to the tables or the nails. The nails may not be altered.

Scoring: You will receive

- A. 10 points (50 points maximum) for each weight held by the bridge
- B. Up to 30 points for how creatively you use the materials.
- C. Up to 20 points for how well your team works together.

Suspension Bridge For Appraisers Only:

1. The set-up consists of two tables. There is also a table with materials.

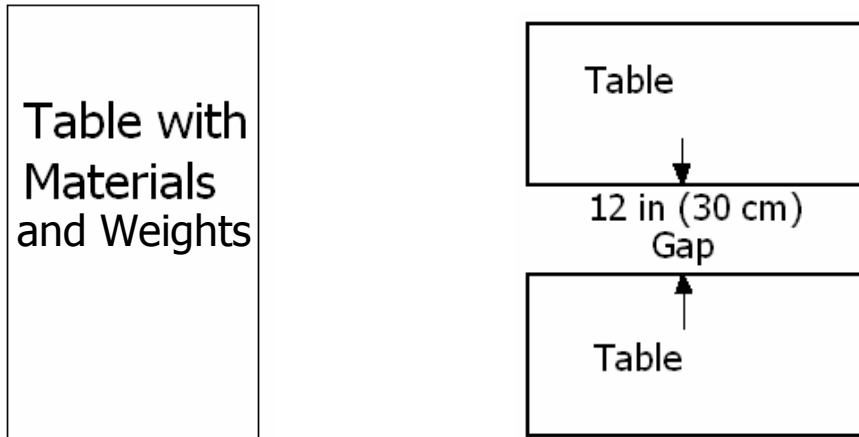

2. Be sure to warn the team when there is 1 minute remaining and 30 seconds remaining in Part One.
3. If a team member touches the bridge during Part Two, they should be warned and any points the team may have gained as a result should not be awarded.
4. The weights should be metal spoons with ornament hangers attached.

Suspension Bridge

Challenge: Your **TASK** is to create a bridge and hang weights from it.

Time: You will have up to 5 minutes to use your IMAGINATION to create your bridge and then up to 2 minutes to hang weights for score.

Set-up: In the middle of the room are two tables. In addition, there is a table with materials.

Procedure:

Part One (5 minutes):

- Use the materials to create a bridge between the tables.
- You may practice hanging weights in Part One, however the weights added will not receive score.
- In order to proceed to Part Two, you must have a bridge between the two tables at the end of Part One.
- You will be warned when you have one minute remaining and 30 seconds remaining in Part One.

Part Two (2 minutes):

- Hang weights for score.
- **No team member may touch the bridge during Part Two.**
- In order for a weight to be scored, it must be held for ten seconds without any team member touching the bridge.

Scoring: You will receive

- A. 10 points (50 points maximum) for each weight held by the bridge
- B. Up to 30 points for how creatively you use the materials.
- C. Up to 20 points for how well your team works together.

Suspension Bridge

Materials:

(Tape to Table)

2 Pieces of Paper

4 Straws

1 Pencil

3 Mailing Labels

1 Piece of Foil

3 Pieces of String

3 Cards

4 Nails

The mailing labels may NOT be attached to the tables or the nails. The nails may not be altered.

Instant Challenge
Entry and Advanced Levels
Tall and Strong

Challenge: Your **TASK** is to create a structure that will hold weight without becoming shorter.

Time: You will have up to 5 minutes to use your **IMAGINATION** to build your structure and then up to 2 minutes to add weights for score.

Set-up: In the middle of the room is a taped square. In addition, there is a table with materials.

Procedure:

•**Part One** (5 minutes): Use the materials to create a structure within the taped square. You may practice adding weights in Part One, however the weights held will not receive score. In order to proceed to Part Two, you must have a structure within the taped square by the end of Part One. You will be warned when you have one minute remaining and 30 seconds remaining in Part One.

•**Part Two** (2 minutes): At the beginning of Part Two, the Appraisers will measure the height of our structure. Then, add weights for score. After each weight is added, the Appraisers will measure the height of the structure. A weight will receive score only if it touches the top of the structure. In order to receive score, after the weight is added, the height of the structure may not be more than 1 inch (2.5 cm) shorter than the height at the beginning of Part Two. **No team member may touch the structure during Part Two.**

Materials:

1 Piece of Paper 4 Straws 1 Piece of String 3 Rubber Bands
5 Paper Clips 3 Cards 3 Mailing Labels

The mailing labels may NOT be attached to the floor.

Scoring: You will receive

- A. 1 point for each inch (2.5 cm) tall your structure is at the beginning of Part Two.
- B. 5 points (25 points maximum) for each weight held by your structure that touches the top of the structure and does not cause it to become more than 1 inch (2.5 cm) shorter.
- C. Up to 30 points for how creatively you use the materials.
- D. Up to 20 points for how well your team works together.

Tall and Strong

For Appraisers Only:

1. The set-up consists of a taped square. There is also a table with materials.

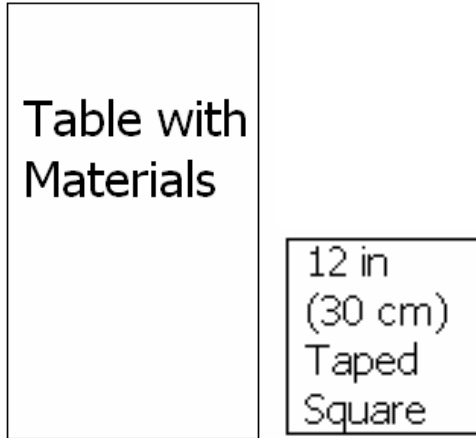

2. Be sure to warn the team when there is 1 minute remaining and 30 seconds remaining in Part One.
3. If a team member touches the structure during Part Two, they should be warned and any points the team may have gained as a result should not be awarded. If the team needs to move the structure into the taped area, they may.
4. Be sure to measure the height of the structure at the beginning of Part Two and after each weight is added. Take all measurements to the nearest 1/8 inch (3 mm).

Tall and Strong

Challenge: Your **TASK** is to create a structure that will hold weight without becoming shorter.

Time: You will have up to 5 minutes to use your **IMAGINATION** to build your structure and then up to 2 minutes to add weights for score.

Set-up: In the middle of the room is a taped square. In addition, there is a table with materials.

Procedure:

Part One (5 minutes):

- Use the materials to create a structure within the taped square.
- You may practice adding weights in Part One, however the weights held will not receive score.
- In order to proceed to Part Two, you must have a structure within the taped square by the end of Part One.
- You will be warned when you have one minute remaining and 30 seconds remaining in Part One.

Part Two (2 minutes):

- At the beginning of Part Two, the Appraisers will measure the height of our structure.
- Then, add weights for score.
- After each weight is added, the Appraisers will measure the height of the structure.
- A weight will receive score only if it touches the top of the structure.
- In order to receive score, after the weight is added, the height of the structure may not be more than 1 inch (2.5 cm) shorter than the height at the beginning of Part Two.
- **No team member may touch the structure during Part Two.**

Scoring: You will receive

- A. 1 point for each inch (2.5 cm) tall your structure is at the beginning of Part Two.
- B. 5 points (25 points maximum) for each weight held by your structure that touches the top of the structure and does not cause it to become more than 1 inch (2.5 cm) shorter.
- C. Up to 30 points for how creatively you use the materials.
- D. Up to 20 points for how well your team works together.

Tall and Strong
Materials:
(Tape to Table)

- 1 Piece of Paper
- 4 Straws
- 1 Piece of String
- 3 Rubber Bands
- 5 Paper Clips
- 3 Cards
- 3 Mailing Labels

The mailing labels may NOT be attached to the floor.

Instant Challenge
Entry and Advanced Levels
Underpass

Challenge: Your **TASK** is to build a bridge and roll a ball under it.

Time: You will have up to 5 minutes to use your **IMAGINATION** to build your bridge and then up to 1 minute to roll a ball under it for score.

Set-up: In the middle of the room is a taped square. In addition, there is a table with materials.

Procedure:

•**Part One** (5 minutes): Use the materials to create a bridge. You may practice rolling balls in Part One, however the balls rolled will not receive score. In order to proceed to Part Two, you must have a bridge within the taped square by the end of Part One. You will be warned when you have one minute remaining and 30 seconds remaining in Part One.

•**Part Two** (1 minute): Roll a ball for score. Only the highest-valued ball may receive a score. A ball may only receive score if it passes from one side of the bridge to the other without the bridge falling over. **No team member may cross the taped line during Part Two.** At the end of Part Two, the Appraisers will measure the height and length of the bridge.

Materials:

1 Styrofoam Cup 20 Toothpicks 5 Marshmallows 5 Chenille Sticks

Scoring: You will receive

- A. 1 point for each inch (2.5 cm) tall your bridge is.
- B. 1 point for each inch (2.5 cm) long your bridge is.
- C. Points for the highest-valued ball that rolls under the bridge:
 - 1 point for a golf ball
 - 5 points for a tennis ball
 - 10 points for a baseball
 - 20 points for a soccer ball
 - 25 points for a basketball
- D. Up to 30 points for how creatively you use the materials.
- E. Up to 20 points for how well your team works together.

Underpass

For Appraisers Only:

1. The set-up consists of a taped square. There is also a table with materials.

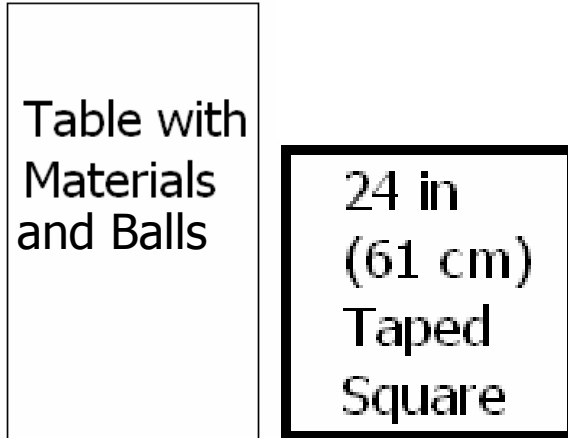

2. Be sure to warn the team when there is 1 minute remaining and 30 seconds remaining in Part One.
3. If a team member crosses the taped line during Part Two, they should be warned and any points the team may have gained as a result should not be awarded.
4. If the team rolls more than one ball, they should be awarded points for the highest-valued ball rolled. The points will be awarded once, regardless of how many times the team rolls the ball.
5. Each of the balls should be clearly labeled with a corresponding point value.

Underpass

Challenge: Your **TASK** is to build a bridge and roll a ball under it.

Time: You will have up to 5 minutes to use your IMAGINATION to build your bridge and then up to 1 minute to roll a ball under it for score.

Set-up: In the middle of the room is a taped square. In addition, there is a table with materials.

Procedure:

Part One (5 minutes):

- Use the materials to create a bridge.
- You may practice rolling balls in Part One, however the balls rolled will not receive score.
- In order to proceed to Part Two, you must have a bridge within the taped square by the end of Part One.
- You will be warned when you have one minute remaining and 30 seconds remaining in Part One.

Part Two (1 minute):

- Roll a ball for score.
- Only the highest-valued ball may receive a score.
- A ball may only receive score if it passes from one side of the bridge to the other without the bridge falling over.
- **No team member may cross the taped line during Part Two.**
- At the end of Part Two, the Appraisers will measure the height and length of the bridge.

Scoring: You will receive

- A. 1 point for each inch (2.5 cm) tall your bridge is.
- B. 1 point for each inch (2.5 cm) long your bridge is.
- C. Points for the highest-valued ball that rolls under the bridge:
 - 1 point for a golf ball
 - 5 points for a tennis ball
 - 10 points for a baseball
 - 20 points for a soccer ball
 - 25 points for a basketball
- D. Up to 30 points for how creatively you use the materials.
- E. Up to 20 points for how well your team works together.

Underpass

Materials:

(Tape to Table)

1 Styrofoam Cup

20 Toothpicks

5 Marshmallows

5 Chenille Sticks